

# Technical Manual

## Glassfront Bev-Max 2 Vender

Model DN5800

0001-8446CD to 0001-8487AE (including production run 8511)



Operation  
Service  
Parts  
Troubleshooting  
Manual

Manufactured by

CRANE

**Dixie Narco**  
Vending Systems

Dixie-Narco, Inc.  
P.O. Drawer 719  
Williston, SC 29853-0719  
803-266-5001  
fax: 803-266-5049  
Visit us on the web: [www.dixienarco.com](http://www.dixienarco.com)

803,904,050.21

# Table of Contents

<b>GENERAL INFORMATION</b> .....	4
Vender Safety Precautions.....	4
Product Identification.....	4
Physical Characteristics.....	4
<b>INSTALLATION &amp; SETUP</b> .....	4 - 9
Receiving Inspection.....	4
Unpacking The Vender.....	4 - 5
Electrical Requirements.....	5
Ground The Vender.....	5
Installation & Setup Instructions.....	5 - 6
Placing the Vender On Location.....	6 - 7
Leveling the Vender.....	7
Spacing the Vender.....	7
Installing Labels & Product ID Cards.....	7
Coin Changers And Other Accessories.....	7
Set Temperature Control.....	8
Loading the Vender.....	8
Loading the Coin Changer.....	8
Power AC Distribution Box.....	8
Vending Machine Controller (VMC).....	8
Keypad.....	8
Digital Display.....	8
Refrigeration System.....	8 - 9
Shelf Assembly.....	9
Double Gate Assembly.....	9
Slide / Pusher Assembly.....	9
Motor Picker Assembly.....	9
<b>PROGRAMMING</b> .....	10 - 23
General.....	10
External Display Items.....	10
Normal Operation Messages.....	10
Initial Programming.....	10 - 11
Quick Reference Menu Items.....	12
Service Mode.....	13 - 15
Test Mode.....	15 - 18
Setup Mode.....	18 - 22
Setup Mode 2.....	22 - 23
<b>GENERAL MAINTENANCE</b> .....	24
Power.....	24
Cleaning.....	24
<b>MAJOR COMPONENT DESCRIPTION</b> .....	25
AC Distribution Box.....	25
<b>CONTROL BOARD</b> .....	26
Controller Connections.....	26
<b>TROUBLESHOOTING</b> .....	27 - 42
XY Issues.....	27 - 29
XY Not Working Flow Chart.....	30
Plunger Home Flow Chart.....	31
X Axis Home Flow Chart.....	32
Y Axis Home Flow Chart.....	33
XY Slams to Top/Right or Left Flow Chart.....	34
Picker Cup Not Working Flow Chart.....	35
Picker Cup at Wrong Location Y Axis Flow Chart.....	36
Picker Cup at Wrong Location X Axis Flow Chart.....	37
Delivery Port Door Flow Chart.....	38

Coin Acceptance.....	39
Bill Acceptors .....	39
Control Board.....	39
All Coins Rejected Flow Chart.....	40
All Bills Rejected Flow Chart .....	41
Incorrect Change Dispensed Flow Chart .....	42
Selection Will Not Vend Flow Chart.....	43
Ice / Frost on Evaporator Flow Chart.....	44
Condensate on Outside of Product Door Flow Chart.....	44
Compressor Will Not Stop Flow Chart.....	44
Compressor Will Not Start Flow Chart .....	45
Machine Not Cooling Flow Chart.....	46
<b>ELECTRICAL DIAGRAMS &amp; SCHEMATICS .....</b>	<b>47 – 55</b>
Block Diagram Domestic .....	47
Block Diagram Export.....	48
Vender Wiring Diagram Cabinet (Domestic & Export) .....	49 - 50
Vender Wiring Diagram Door (Domestic & Export) .....	51
Vender Wiring Diagram Power & Lighting (Domestic only).....	52
Vender Wiring Diagram Power & Lighting (Export only) .....	53
Compressor Parts Diagram .....	54
AC Distribution Box J2 Port Test Voltages.....	55
<b>PARTS LIST AND DIAGRAMS .....</b>	<b>56 – 84</b>
Machine Front View .....	57 – 58
Cabinet Detail Product Area .....	59 – 60
Cabinet Detail Service Door Area.....	61 – 62
XY Motor Picker Unit .....	63 - 64
Service Door Outside .....	65 – 66
Service Door Inside .....	67 – 68
Gate Tray Detail.....	69 – 70
AC Distribution Box .....	71 - 72
Lighting .....	73
Refrigeration Unit Fin & Tube Condenser .....	74 – 76
Electronics .....	77
Harnesses.....	78 – 79
Labels / Decals / Misc.....	80
Screws & Nuts .....	81 – 82
Washers, Bolts, & Misc. Hardware .....	83 – 85

## VENDER SAFETY PRECAUTIONS

Please read this manual in its entirety. This service information is intended for use by a qualified service technician who is familiar with proper and safe procedures to be followed when repairing, replacing or adjusting any Dixie-Narco vender components. All repairs should be performed by a qualified service technician who is equipped with the proper tools and replacement components, using genuine Dixie-Narco factory parts.



Warning

*REPAIRS AND/OR SERVICING ATTEMPTED BY UNQUALIFIED PERSONS CAN RESULT IN HAZARDS DEVELOPING DUE TO IMPROPER ASSEMBLY OR ADJUSTMENTS WHILE PERFORMING SUCH REPAIRS. PERSONS NOT HAVING A PROPER BACKGROUND MAY SUBJECT THEMSELVES TO THE RISK OF INJURY OR ELECTRICAL SHOCK WHICH CAN BE SERIOUS OR EVEN FATAL.*

## PRODUCT IDENTIFICATION

First production of Bev Max 2 Venders was March 2005. The production date of Dixie-Narco products is determined by the date code incorporated in the serial number.

The vender serial number takes the form xxxx-yyyy zz. The first 4 digits (xxxx) identify the specific vender. The next 4 digits (yyyy) identify the manufacturing run that the vender was built in. The last two alpha characters (zz) identify the quarter and the year the vender was built. The first alpha character identifies the quarter as follows:

- A= 1<sup>st</sup> Quarter
- B= 2<sup>nd</sup> Quarter
- C= 3<sup>rd</sup> Quarter
- D= 4<sup>th</sup> Quarter

The second alpha character identifies the year:

- D = 2005                      H = 2009
- E = 2006                      I = 2010
- F = 2007                      J = 2011
- G = 2008

## PHYSICAL CHARACTERISTICS

	DN5800
<b>HEIGHT</b>	72" (1828.8 mm)
<b>WIDTH</b>	47" (1193.8 mm)
<b>DEPTH CABINET</b>	32" (812.8 mm)
<b>DEPTH WITH SERVICE DOOR</b>	33.5" (850.9 mm)
<b>BASE</b>	4.5" (114.3 mm)
<b>SHIPPING WEIGHT</b>	764 lbs. (346kg)
Glass door is 37.5" (876.3 mm) wide, 67" (1701.8 mm) high	

## RECEIVING INSPECTION

### DO NOT STORE THE VENDER OUTSIDE.

Upon receipt, inspect the vender for any shipping damage. If there is any damage, have the delivery driver note the damage on the bill of lading and notify Dixie-Narco. Although the terms of sale are FOB shipping point, which requires the consignee to originate shipping damage claims, Dixie-Narco will gladly help if you must file a claim.

## UNPACKING THE VENDER

Remove the stretch wrap, fiberboard edge protectors and corrugated front protector from the outside of vender.



Do not store the vender with stretch wrap on. Stretch wrap could bond to the vender's surface, which could damage the finish.

Remove the shipping boards from the bottom of the vender. The shipping boards are attached by the leveling legs. To avoid unnecessary damage to the leveling legs or base, remove the shipping boards by using a 1-1/2 inch socket type wrench to unscrew the leveling legs. Be sure to replace the legs after removing the shipping boards.

Once the vender is unpacked, check the recovery unit for any additional parts, price/ product labels, service/operation manual or other information concerning factory-equipped accessories such as coin mech and validator.



**WARNING: TO AVOID THE POSSIBILITY OF A FIRE HAZARD, DO NOT STORE ANYTHING OR ALLOW DEBRIS OF ANY KIND TO ACCUMULATE IN THE BOTTOM OF THE SERVICE AREA, IN AND AROUND THE REFRIGERATION COMPARTMENT OF THE CABINET, OR IN FRONT OF THE EVAPORATOR AND CONDENSER COILS.**



Warning

**WARNING: ENSURE THAT POWER IS DISCONNECTED FROM THE VENDER BEFORE INSPECTING OR REPLACING THE LAMPS, OTHER ELECTRICAL COMPONENTS, OR WORKING WITH OR ADJUSTING THE VENDING MECHANISM. FAILURE TO COMPLY WITH THESE INSTRUCTIONS MAY SUBJECT THE USER TO THE RISK OF ELECTRICAL SHOCK OR MECHANICAL INJURY, WHICH CAN BE SERIOUS OR FATAL.**



## ELECTRICAL POWER NEEDED

Refer to the cabinet serial number plate to determine the correct voltage and frequency for the machine. In the US and Canada this is 120Vac, 60Hz, 1P. In Europe, Australia, and other export countries, this is 220/230/240Vac, 50Hz, 1P depending upon your country voltage. The serial plate also specifies the ampere rating of the machine. This machine must be plugged into a properly rated receptacle with its own circuit protection (fuse or circuit breaker).

**DO NOT USE AN EXTENSION CORD.**

## GROUND THE VENDER

The vender is equipped with a three-wire power supply cord and MUST be plugged into a properly grounded outlet.



**DO NOT REMOVE THE GROUND PIN OR IN ANY WAY BYPASS, MODIFY, DEFEAT, OR DESTROY THE GROUNDING SYSTEM OF THE VENDER.**

If the outlet will not accept the power cord plug, contact an electrician to install a proper AC outlet.



Warning

**FAILURE TO COMPLY WITH THESE INSTRUCTIONS MAY SUBJECT THE USER TO THE RISK OF INJURY OR ELECTRICAL SHOCK WHICH CAN BE SERIOUS OR FATAL. PERIODICALLY INSPECT THE POWER SUPPLY CORD FOR DAMAGE. IF THE CORD BECOMES DAMAGED IT MUST BE REPLACED WITH THE SAME SIZE AND TYPE CORD. CONTACT DIXIE-NARCO FOR ASSISTANCE.**

## INSTALLATION AND SETUP INSTRUCTIONS

### ELECTRONIC LOCK

The electronic lock provided in the vender consists of a door mounted, motor driven 2 point latching system, cabinet mounted latch and strike system, an infrared controlled CPU, and a remote control key (FOB). The design is modular and allows for easy field service.

The electronic remote key (FOB) features a rolling code system which cannot be decoded if it is lost or stolen. After the vender has been unlocked, a new key can be programmed into it any number of times. If a key is lost or stolen, it is recommended you change the lock code in the field as soon as possible. Changing the lock code requires a new key and pressing the PROGRAM button on the lock inside the vender. The lock does not need to be changed for re-keying.

**Important:** For security reasons all Electronic Door Lock Venders are shipped less keys. Customers will need to contact the Electronic Door Lock manufacturer to order keys.

A power bypass connector, located in the product delivery port, allows auxiliary power to be applied via a battery pack to the electronic lock in the event that power is not available or there has been a failure of the internal power supply. In the event of an emergency, battery power is applied to the connector and the door can be opened and closed using the FOB.

The electronics uses an infrared transmission system, which functions similar to a television remote control. The transmission signal is line-of-sight, which requires you to aim the remote at a specific place at close range to prevent the accidental opening of several venders at the same time.

## TO OPEN THE ELECTRONIC DOOR LOCK:

1. Plug the vender into a properly powered outlet.
2. Hold the key FOB 0 to 3 inches in front of the Delivery Port Door and press the button on the key FOB.

Note: The wide end of the FOB should face the door.

3. The lock will begin releasing the door. The display will indicate **OPENED**. After the motor has stopped running, you can pull the door open.

## TO CLOSE THE ELECTRONIC DOOR LOCK:

### **CAUTION: DO NOT SLAM THE DOOR CLOSED.**

Slamming the door closed can damage the electronic locking device.

1. Push the door to the cabinet until the lock motor starts. The display will indicate: **CLOSED**
2. Continue to push the door for approximately 2 to 3 seconds after the lock motor starts. The lock will pull the door closed tightly.
3. When the lock motor stops the door will be locked. Before leaving the vender, ensure that the door is locked.

The electronic door lock assembly is supplied by Tri Teq Lock and Security. Dixie-Narco, Inc. does not carry parts for the Tri Teq Electronic Door Lock. For parts and assistance, please contact:

Tri Teq  
701 Gullo  
Elk Grove Village, IL 60007  
Tel: 847-640-7002  
Fax: 847-640-7008  
Email: gary@triteqlock.com

## MANUAL LOCK

Open the service door on the right side using the key provided in the coin return cup, or if shipped with a locking clip, remove the clip and install the lock. Ensure there is no power to the AC Distribution Box. On venders with a main power switch on the AC Distribution Box the switch needs to be in the OFF position. On venders with a main power quick disconnect plug on the AC Distribution Box the quick disconnect plug needs to be unplugged. Check that all connectors are firmly seated on the control board and at the various components on the service door (coin mech, keypad, etc.).

Retrieve the main power plug from the hole in the rear of the vender and plug the cord in a properly grounded 120VAC, 15 Amp receptacle (U.S. and Canada).

Open the service door and apply power to the AC distribution Box (if equipped with a bill acceptor, the acceptor should cycle twice). The display on the door will briefly show the software version in use as "Software ###.## (ie 080.01) followed by the default idle message "ENJOY A REFRESHING DRINK", the fluorescent lamp should be lit and the cooling unit should start. If the display shows "OUT OF SERVICE", or the cooling unit fails to start, refer to the TROUBLESHOOTING SECTION beginning on page 28.

## SERVICE NOTE

### Battery Backup

The battery backup is used to maintain the date and time in case of power interruptions, or any time the main power is off. When the vender is shipped, the battery is connected and memory is being maintained. If the vender is to be stored for long periods of time, disconnecting the battery is recommended. The following steps will guide you through this procedure.

- Open the service door, turn the main power switch to the off position or unplug the main power harness located on the front of the power box.
- Locate the control board mounted on the rear wall.
- Remove the battery from its holder (B 1).

## PLACING THE VENDER ON LOCATION

### !! CAUTION !!



*DO NOT TRANSPORT THE VENDER TO OR FROM THE LOCATION LOADED WITH PRODUCT OR DAMAGE TO THE VENDER MAY RESULT.*

The vender is intended for **INDOOR USE ONLY**. It should be kept out of direct sunlight and away from any heat source. This machine is not suitable for installation in an area where a water jet or hose and nozzle may be used.

The vender must be on a solid, flat and level surface. Ensure the flooring can bear the weight load of a fully loaded vender (approximately 1109 lbs. or 413kg). The vender must be positioned close enough to an electrical outlet so that an extension cord is not required. If the machine will be subject to user misuse or vandalism, it is recommended that the vender be secured to the floor or wall as described in Dixie-Narco Technical Bulletin 344. Due to the large size

and weight of the Vender, never attempt to move the Vender with a Hand Truck or Stair Climber. Use a pallet jack or Vender/Cooler Dollies at all times when moving the Vender. The vender should never be slid or pushed in place. Never side load the leveling legs; doing so will cause damage to the legs. Do not transport the vender to or from customer locations loaded with product, as damage may result due to excessive weight. Call the Dixie-Narco Technical Service Department or your Dixie-Narco Representative for assistance.

### **LEVEL THE VENDER**

Adjust the front leveling legs, ensuring that an even gap exists between the glass door and the top security angle and receiver box, and then level the cabinet front to rear. A carpenter's level will help verify that the vender is level. Leveling legs are adjusted using a wrench or socket 1 ½" in size. If the vender is to be used in a bank of equipment, check the top and sides for proper alignment. If you are unable to properly level the vender, select an alternate location. NEVER PLACE OBJECTS UNDER THE LEVELING LEGS OF THE VENDER

### **DANGER**

*THE VENDER MUST BE PROPERLY LOCATED AND LEVELED. IF THE MACHINE WILL BE SUBJECT TO USER MISUSE OR VANDALISM IT IS RECOMMENDED THAT THE VENDER BE SECURED TO THE FLOOR OR WALL AS DESCRIBED IN DIXIE-NARCO TECHNICAL BULLETIN 344 TO MINIMIZE THE RISK OF INJURY OR DEATH FROM TIPPING. CALL THE DIXIE-NARCO TECHNICAL SERVICE DEPARTMENT OR YOUR DIXIE-NARCO REPRESENTATIVE FOR ASSISTANCE.*



### **SPACE THE VENDER**

Do not block the rear of the vender. Maintain a minimum of 4 inches (10 cm) from the wall to ensure adequate airflow to the condenser and compressor. At the rear of the vender, make sure nothing obstructs the air exhaust at the bottom of the cabinet.

### **WARNING**

*TO AVOID THE POSSIBILITY OF A FIRE HAZARD, DO NOT STORE ANYTHING OR ALLOW DEBRIS OF ANY KIND TO ACCUMULATE IN THE BOTTOM OF THE DOOR, IN THE BOTTOM OF THE SERVICE AREA, IN AND AROUND THE REFRIGERATION COMPARTMENT OF THE CABINET, OR IN FRONT OF THE EVAPORATOR AND CONDENSER COILS.*



### **INSTALLING PRICE LABELS**

Pricing labels included in the literature package kit. They range in price from .25 to 9.95. Remove the pricing label sheets from the service manual package and gently remove the label corresponding to the vend price of each selection by tearing at the perforation. The label is installed at the top of the front knuckle. Once installed, push the label firmly against the front of the knuckle. This will insure the label is locked in place.

### **INSTALLING PRODUCT ID CARDS**

To assist with consistent loading, product ID cards are included for the slide assemblies with every vender and should be installed into the product pusher to designate to the route driver which product the column is set for. To install the flavor card, simply detach it from the sheet at the perforation and slide it into the slots in the product pusher.

### **COIN CHANGERS & OTHER ACCESSORIES**

The vender can have an MDB coin changer installed and can have an MDB bill acceptor installed as well. Note: Bev Max 2 will work with an MDB bill acceptor only. If the MDB coin changer and other MDB accessories are not factory installed, refer to the instructions received from the manufacturer of the MDB coin changer and other MDB accessories for proper set-up and installation.

The vender will support the following Domestic MDB coin changers:

Coinco 9302GX, USG-701 Quantum  
Mars TRC-6510, TRC-6512, TRC-4010  
Conlux CCM-5G 1-2-3-4-5

The vender will support the following domestic MDB Bill validators:

Coinco BA-30 B, BA-50B      Coinco Mag 50  
Mars VN 2512      Conlux NBM-3000 Series

The vender will support MDB card readers.

## SETTING THE TEMPERATURE CONTROL

This vender is equipped with an electronic temperature sensor and a manual defrost thermostat. This temp sensor is factory pre-set to maintain a cabinet temperature of 37 degrees Fahrenheit. It is also a good practice to ensure the proper operating temperature prior to installing the vender on location. To set the temperature, apply power to the vender and allow it to run for several hours with the glass door closed or until the minimum cabinet temperature is achieved. Then, using the method below, verify the temperature inside the cabinet:

With an electronic temperature sensor, use the keypad on the service door to show cabinet temperature in Fahrenheit by pressing the F key followed by the asterisk (\*) key or in Centigrade by pressing the C key followed by the asterisk key. The temperature will be shown on the digital display located on the front of the service door.

The defrost control is located on the side of the refrigeration unit. The defrost control is preset and is not adjustable.

## LOADING THE VENDER

### CAN/BOTTLE DRINK TRAYS

The Bev Max 2 Vender does not require spacers or shims to vend most packages. Load product in each column one package at a time insuring that the package being loaded is in front of the product pusher. Insure that the package is stable within the column (doesn't move excessively from side to side). After loading the vender, test vend each column to insure proper operation. Please contact a Service Representative or refer to the proper Technical Publication for any special settings you may need.

### LOADING CHANGE TUBES

The changer tubes can be loaded using one of the following methods:

1. Load the coin mechanism with coins to the desired level by inserting coins in the loading slots on the coin tube front.

Minimum coin tube levels are:

6-8 nickels

7-8 dimes

5-6 quarters

Note: A low coin level in the coin tubes will interfere with operation of the bill validator.

2. For exact cash accountability and to insure maximum dollar bill acceptance, load the mechanism utilizing the coin insert slot on the front of the vender while in the coin tube fill/dispense mode in the test menu. (see

page 17 in the programming section for more information)

(For additional information about coin mechanism, refer to the manufacturer's instructions.)

### POWER AC DISTRIBUTION BOX

The power distribution box is where the 120VAC input voltage is broken down to the main operating voltages of the vender (24 VAC and 12 VAC) by a transformer. Those voltages are sent to the controller via the P1 (3 pin) connector. It also contains 3 fuses that protect the VMC, transformer, and motors. The power distribution box also distributes AC power to the lights, evaporator fan, and refrigeration system, which are always energized when the vender is powered up. It is located inside the service area, mounted to the back wall.

### VENDING MACHINE CONTROLLER (VMC)

The vending machine controller is the heart of the Glass Front Vender and is located on the rear wall inside the service area. It is flash programmable and may or may not include the program chip (EPROM), which controls all aspects of the vender. It also contains the power supply which regulates the voltages required to operate the motors as well as the coin mechanism, digital display and all logic functions in the vender.

### Keypad

The keypad is located on the front of the service door. It consists of a 6 inch X 3 inch matrix, membrane switch pad and an overlay. The pad utilizes the letters A thru F on the left side and numbers 1 thru 0 along with the \* symbol and Clr to the right. The keypad is where the vender programming is accomplished and where the customers make their selections.

### DIGITAL DISPLAY

The digital display is located directly above the keypad on the front of the service door. It is used to convey information to the consumer as well as to the person programming the vender.

### REFRIGERATION SYSTEM

The refrigeration system is a single piece unit and is hermetically sealed. In the EM2001 model consist of a ½ horsepower compressor, with a single fin and tube style condensing unit with one fan, the condensation overflow pan and the evaporator. The evaporator is located behind the panel on the back right side of the cooling compartment directly adjacent to the bottom shelf. The remainder of the unit is located behind the refrigeration unit cover panels, mounted in the bottom of the cabinet. This unit is designed for easy removal and replacement from the front of the vender as a complete assembly. An electronic thermostat regulates the cabinet temperature. The bulb of the thermostat is attached



to the evaporator coils and reads the temperature of air being pulled in to the evaporator coil.

### **SHELF ASSEMBLY**

Typically, there are 5 shelf assemblies in every vender; however, this can vary depending upon the configuration specified at the time of ordering. Each can/bottle shelf consists of 9 columns. Each shelf is capable of holding a variety of packages. The shelf assembly consists of the tray, where all of the following parts are mounted: Double Gate assembly, and the slide/pusher assembly. These items are discussed in detail below.

### **DOUBLE GATE ASSEMBLY (Can/Bottle Trays)**

The double gate assembly is mounted on the front portion of the tray assembly and contains the vending mechanism. Incorporated in the gate assembly are the front and rear knuckle assemblies as well as the product kicker. In standby operation, the front knuckle is in the blocking position, which holds the front displayed product in position to be vended. The rear knuckle assembly is in a flat position, which allows product to enter the gate area, and the kicker is flush to the rear knuckle assembly. A stainless steel pin is inserted through the rear most portion of the front knuckle assembly and connects to a gear box below the tray. When a selection is made, the plunger pushes the lever toward the back of the tray. At the same time the front knuckle is opened into a flat position, the rear knuckle is closed to a blocking position, holding the remaining product out of the gate area, and the kicker is extended to firmly push the front displayed product off of the tray. The plunger is energized for approximately 1-½ seconds to allow ample time for the displayed product to be ejected from the shelf. The plunger is then released and the front knuckle returns to the blocking position, the rear knuckle and kicker return to their standby position and the next product slides into the vend display position.

### **SLIDE/PUSHER ASSEMBLY (Can/Bottle Trays)**

The slide/pusher is located on the bottom of each product column. Its purpose is to provide a slick, friction resistant surface for the product to rest on. The tall product pusher is mounted on the top of the slide and incorporates a coil spring in the body that attaches to the bottom of the slide through a slit. This spring adds needed tension to insure that all products in the column remain tight against each other and are allowed to progress into the gate area. Although these pushers reduce the effects of dirt and grime, periodic cleaning and lubrication of the slides is recommended. **DO NOT USE SOLVENTS OR ABRASIVE MATERIALS TO CLEAN ANY PORTION OF THE TRAY.**

### **MOTOR PICKER ASSEMBLY**

The motor picker assembly is located on the XY door vend mechanism. Its purpose is to pick the product from the column and deliver the product to the delivery port. The motor picker assembly is mounted on the XY assembly and bolts in position.

The X axis runs left to right. The X axis assembly is cabinet mounted to prevent any cabinet torque and has one belt to synchronize the top and bottom when the X moves left or right.

The Y axis runs up and down and has the Picker Cup Assembly attached. A top channel is used to contain and hide the e chain and wiring.

Both X and Y motors have encoders for positioning.

## PROGRAMMING

### GENERAL INFORMATION

In order to fully utilize the many features of your vender it is important that you first understand the options available and procedures for programming the vending controller unit (control board).

All programming, testing, and service functions are accomplished by using the keypad in an easy to follow, display prompted format. There are four modes of operation for servicing, testing, and setting up your vender. The modes of operation are accessed by, opening the service door, and pressing the service button on the control board.

The service button will cycle through each of the four modes in turn: Service Mode, Test Mode, Set-Up Mode 1 and Set-Up Mode 2. In each of these modes, the "A" key is used to scroll through the available options/settings within that mode/selection. (Note: In each of the mode selections, pressing the character key next to the listed option will take you directly to that feature - see menu items chart on page 12.), the "\*" key is used as an enter key to select the currently displayed item/feature, and the "CLR" key is used as a done or exit key. Closing the service door or pushing the service door switch will exit the function you are currently in and place the vender back in service.

### EXTERNAL DISPLAY ITEMS (HOT KEYS)

Allows the service technician to view several items via the display without opening the vender. There are four options that can be viewed externally:

1. **Display temperature in degrees "C"**. To view, press the "C" then press the "\*" key. The display will then show the vender's inside temperature in degrees "C".
2. **Display date/time**. To view, press the "D" key, then press the "\*" key. The display will then show the current date and time.
3. **Display temperature in degrees "F"**. To view, press the "F" key, then press the "\*" key. The display will show the vender's inside temperature in degrees "F".
4. **Display current software revision**. To view, press the "B" key, then press the "\*" key. The display will then show the current software revision in the controller.

### NORMAL OPERATION MESSAGES

At initial power-up, the program will start and the display will briefly show the software version in use as Software ###.## (i.e. 080.01), followed by the default idle message, "ENJOY A REFRESHING DRINK".

## INITIAL PROGRAMMING

### DATE/TIME

To set date/time enter "SETUP MODE 1" by opening the service door and pressing the Service Button three (3) times. Press the number "5" and "DATE/TIME" will show on display. Press the "\*" key and display will show the current year, month, date, and time setting currently in the system in following format: 2005 Apr 28 15:45 with the year highlighted. Press the numbers to enter the current year and Month will then be highlighted. To change the month press the A key to scroll forward through the months or the B key to scroll backward through the months. With the correct month showing, press the "\*" key to save and Date will then be highlighted. Press the numbers to enter the current date and then the hour will then be highlighted. Note: Hours are shown in 24 hour format. Press the numbers to enter the current hour and then the minutes will then be highlighted. Press the numbers to enter the current minutes. The display will then change to show "OK? \*=Y (Yes) CLR = N (No)" and the setting you entered. You must press \* Key to save the new date and time entered. Pressing CLR Key will revert to the date and time setting. Press the "CLR" key to return to "SETUP MODE".

### SET PRICES

To set the prices enter the "SERVICE MODE" by opening the service door and pressing the Service Button once. Allows the setting of regular and secondary prices for an individual item, a complete tray, or the entire machine. Factory setting is \$99.95. Press the number "7" on the keypad and the display will show "SET PRICE". Press the "\*" key and the display will show "1 = Regular Pricing, 2 = Secondary Pricing". To set regular prices press number 1 key and display will show "Regular \$##.##". To set price:

1. **All selections**. Press the keypad numbers of the price you wish to use. As numbers are entered the numbers will shift in from the right as they are entered. Note: The CLR key will remove the last # of the price. Once the desired price is showing on the display press the "\*" key and the display will show "PR\$##.## All Set", press "\*" to set more prices or CLR to return to SET PRICES. Press CLR Key again to return to SERVICE MODE.
2. **One tray**. Press the keypad numbers of the price you wish to use. As numbers are entered the numbers will shift in from the right as they are entered. Note: The CLR key will remove the last # of the price. Once the desired price is showing on the display press the tray letter desired for setting price. Press "\*" and display will show "PR \$##.## B(tray letter) Row Set", press "\*" to set more prices

or CLR to return to SET PRICES. Press CLR Key again to return to SERVICE MODE.

- 3. Single selection.** Press the keypad numbers of the price you wish to use. As numbers are entered the numbers will shift in from the right as they are entered. Note: The CLR key will remove the last # of the price. Once the desired price is showing on the display press the selection desired for setting price. Press "\*" and display will show "PR ###.## B1 Selection Set", press "\*" to set more prices or CLR to return to SET PRICES. Press CLR Key again to return to SERVICE MODE.

The last price entered for a selection is the price that will be used. For example, If one price on the A tray was set to \$1.50 using option 3 above and you wish to change the remaining selections on that tray using option 2, the pricing for the entire tray would take precedence. Conversely, if the price was set using option 2 first followed by the single selection using option 3, the pricing for the remainder of the shelf would remain and the new price for the single selection would change to the new value.

Press the "CLR" key to return to "SERVICE MODE".

### SET NOT AVAILABLE TIMES

Password protected. Before entering or changing this setting you must enter the password if one has been assigned. This mode allows up to 4 different time periods that use of the machine may be restricted. To set Not Available Times enter the "SETUP MODE 1" by opening the service door and pressing the Service Button 3 times. Press the number 3 key; the display will show "SET NOT AVAIL TIME". Press the "\*" key and the display will show "Select Block (1 –

4): Press number 1 Key to set Select Block 1 available settings, Key 2 for Select Block 2, etc... Once you select the Select Block # you wish to set the display will show "Start MTWTFSS Stop 1 00:00 NNNNNNNN 00:00" with the start time hour highlighted. Press the numbers to enter the hour you wish to start select block (Note: hour setting is in 24 hour format.) and then the minutes will be highlighted. Press the number keys to enter the minutes and then the first day of the weeks current setting will be highlighted. To change the setting to no press key 2, to yes press key 1. This will change each setting left to right one day at a time until all are set then Stop time hour will be highlighted. Press the numbers to enter the hour you wish to stop select blocking and the minutes will be highlighted. Press the numbers to set the minutes and the display will show "OK? \* = Y CLR = N" press the \* Key to save these settings or CLR Key not to save settings and display will change to show which selections are assigned to this block. Press \* Key and display will show "Enter Selection". Press the Keys of the selections you wish to disable followed by \* and display will show "Disabled Continue? \* = Y CLR = N". Note: If you press a tray letter (ie A) followed by the \* Key that entire tray will be set to be disabled. Once you have selected all settings and the display shows "Disabled Continue? Or Enabled Continue? \* = Y CLR = N" press the CLR to return to "SET NOT AVAIL TIME". Press CLR again to return to "SETUP MODE 1".

## BEV-MAX 2 SERVICE MODE MENU ITEMS

(080.21 Menu shown)

### SERVICE MODE

- A Next Item
- B Cash Box
- C Sales
- D Display Temperature
- E Set Refrig Temp
- F Clear Totals
- 1 Number Sold
- 2 Disable Item
- 3 Sales by Column
- 4 Escrow
- 5 Force Vend
- 6 Set Temperature (F or C)
- 7 Set Prices (Regular & Secondary)
- 8 Set Shelf Location (G, M1, M2, D, E1, E2)
- 9 Relay Toggle
- 0 Clear Errors

### SETUP MODE 1

- A Next Item
- B Enter Message
- C Clear Message
- D *Enable/Disable \$*
- E Set Happy Hour Time
- F *Master Reset*
- 1 Machine Number
- 2 Set Happy Hour
- 3 *Set Not Avail. Time*
- 4 Consumer Overpay
- 5 Date/Time
- 6 Total Sales
- 7 *Health Control*
- 8 *Update Software*
- 9 Set Lights Off Time
- 0 *Enter New Password*

---

### TEST MODE

- A Next Item
- B List Errors
- \*C Not Used
- \*D Not Used
- E Keypad Test
- F Factory Diagnostics
- 1 Tube Fill/Dispense
- 2 Daylight Savings Time
- 3 Not Available Mode
- 4 Credit Timer Mode
- 5 Door Open
- 6 Power Out
- 7 Test Health Guard
- 8 Display Health Guard
- 9 Test Vend
- 0 Show Checksums

---

### SETUP MODE 2

- A Next Item
- B STS Enable
- C Custom STS
- D Default STS
- E Display STS
- F Set No Vend Limit
- \*1 Multivend
- \*2 Not Used
- 3 Sold Out Enable
- 4 Price Display
- 5 Storage Temp Enable
- 6 Interval Clearing (On/Off)
- 7 Set Lights Off
- 8 Set Refrigeration Temp
- 9 Set Storage Time
- 0 Set Storage Temp

**\*Note: All menu items with the font in red are not available in the current Bev Max 2 Vender programming.**

Note: all items in *italics* under SETUP MODES require password entry for access if one has been assigned.

**FACTORY DEFAULT REQUIRES NO PASSWORD UNTIL NEW PASSWORD OTHER THAN 0000 IS ENTERED.**

Menu items shown above reflect software revision 804,924,08x.x1 and higher

Service Mode Pages 13 through 15  
Test Mode Pages 15 through 18  
Setup Mode 1 Pages 18 through 22  
Setup Mode 2 Pages 22 through 23

## SERVICE MODE MENU ITEMS

**Note: Menu items in red are not currently available.**

### SERVICE MODE

Enter SERVICE MODE by opening the service door and pressing the Service button once. The display will read **SERVICE MODE**. The following choices are now available:

**NEXT ITEM** - Press key "A"

**CASH BOX** - Press key "B"

Shows the amount of change diverted to the cash box from the coin mechanism since the last CLEAR TOTALS or MASTER RESET. To view the cash box totals, press the letter "B" on the keypad and the display will show "CASH BOX", then press the "\*" key and the display will show Cash Box \$#.##. Press the "CLR" key to return to "CASH BOX". Press the "CLR" key to return to "SERVICE MODE" or press the "A" key to advance to the next menu item below.

**SALES** - Press key "C"

Shows total sales since last CLEAR TOTALS or MASTER RESET. This total includes change not diverted to the cash box and still being held in coin mechanism escrow tubes To view the total sales press the letter "C" on the keypad and the display will show "SALES", then press the "\*" key and the display will show Sales #.##. Press the "CLR" key to return to "SALES". Press the "CLR" key to return to "SERVICE MODE" or press the "A" key to advance to the next menu item below.

**DISPLAY TEMPERATURE** - Press key "D"

Shows the cabinet temperature in degrees Celsius or degrees Fahrenheit. Press the letter "D" on the keypad. The display will show "Display Temperature". Press the "\*" key and the display will show "Display: ON (or OFF) Press "\*" – turn OFF (or ON)". Press the \* Key to toggle on/off or press the CLR Key to not change settings. If "on" is selected the Display will change to "Set Temperature Unit Degrees F (or C) showing the current setting temperature will be displayed. Press F for Fahrenheit or C for Celsius. Press the \* Key to save and return to "Display Temperature." Press the "CLR" key to return to "SERVICE MODE" or press the "A" key to advance to the next menu item below.

**SET REFRIG TEMP** - Key "E"

Allows the service technician to set the average product temperature (set point) for initial pull down

and reload recovery. Press the letter "E" on the keypad and display will show "SET REFRIG TEMP". Press the "\*" key on the keypad and the display will read "tt.tx" where x is Fahrenheit or Celsius and tt.t is the degrees. To change the set point press the key numbers you wish the set point to be (temperature set must be between 32 and 75 degrees F). Press the "\*" key to save the new set point temperature and return to "SET REFRIG TEMP". Press the "CLR" key to return to "SERVICE MODE" or press the "A" key to advance to the next menu item below.

**CLEAR TOTALS** - Press key "F"

Allows the service technician to clear totals in CASH BOX, SALES, NUMBER SOLD, DOOR OPENINGS, POWER OUTAGES, SALES BY COLUMN, and all other interval data. Press the letter "F" on the keypad and the display will show "CLEAR TOTALS". Press the "\*" key, the display will read Clear Interval Data? \* = Y CLR = N. Press the "CLR" key to return to "Clear Totals" with out resetting the totals. Press the selection you wish to use and display will return to "Clear Totals". Press the "CLR" key to return to "SERVICE MODE" or press the "A" key to advance to the next menu item below.

**NUMBER SOLD** - Press key "1"

Shows the total number of items sold since the last CLEAR TOTALS OR MASTER RESET. Press the number "1" on the keypad and the display will show "NUMBER SOLD". Press the "\*" key and the display will show "Number Sold #". Press the "CLR" key to return to "Number Sold". Press the "CLR" key to return to "SERVICE MODE" or press the "A" key to advance to the next menu item below.

**ENABLE ITEM** - Press key "2"

Allows an individual selection, a complete tray, or the entire machine to be enabled or disabled. This is most commonly used when a selection is out of order and you are awaiting parts and do not want the customer to utilize that selection. Press the number "2" on the keypad and the display will show "ENABLE ITEM". Press the "\*" key and the display will read "Enter Selection". There are now three choices:

1. Pressing the "\*" key will toggle between enabled and disabled for the entire machine, the display will show the new state i.e. enabled or disabled and display will show "Blocked (Unblocked) Continue? \* = Y CLR = N.
2. Pressing a tray selection followed by "\*" will show the new state of that tray. (For example, pressing "A\*" will show the new state for the A tray, the display will show the new state i.e. enabled or disabled and

display will show "A Blocked (Unblocked) Continue? \* = Y CLR = N.

3. Pressing an item selection will show the new state of that item; for example, pressing "A1" will show the new state of that item, the display will show the new state i.e. enabled or disabled and display will show "A1 Blocked (Unblocked) Continue? \* = Y CLR = N.

If a selection has been disabled in this mode and the customer tries to purchase from the programmed selection(s), the vender will display "SELECT ANOTHER ITEM". Press the CLR Key to show all items that are blocked or the \* Key to disable more items. Press the "CLR" key to return to "Enable Item". Press the "CLR" key to return to "SERVICE MODE" or press the "A" key to advance to the next menu item below.

### **SALES BY COLUMN** - Press key "3"

Shows the total number sold from each selection since the last CLEAR TOTALS or MASTER RESET. Press the number "3" on the keypad and the display will show "SALES BY COLUMN". Press the "\*" key and the display will read "Select Column". Select the column to be checked (the total number sold from that selection will be on the right side of the display and the item number will be on the left side of the display). Press the "CLR" key to return to "Sales by Column". Press the "CLR" key to return to "SERVICE MODE" or press the "A" key to advance to the next menu item below.

### **ESCROW** - Press key "4"

Allows a bill to be returned if the change return lever is pressed before a selection is made. Factory setting is ESCROW OFF. Press the number "4" on the keypad and the display will read "ESCROW OFF" or "ESCROW ON", depending on the current state. Pressing the "\*" key toggle the vender from ESCROW OFF to ESCROW ON. Example: If "ESCROW OFF" is showing on the display, pressing the "\*" key will disable the escrow function and the display will read ESCROW ON. This feature only affects those machines with a bill validator installed. Press the "CLR" key to return to "Escrow". Press the "CLR" key to return to "SERVICE MODE" or press the "A" key to advance to the next menu item below.

### **FORCE VEND** - Press key "5" (NOT AVIALABLE)

Forces the customer to make a vend by inhibiting the coin return lever once the minimum vend price line has been met or exceeded The coin return lever will not be inhibited if there is not enough credit to vend the lowest priced item or if a vend failure has occurred. Factory setting is "FORCE OFF". Press the number "5" on the keypad the display will read "FORCE OFF" or "FORCE ON", depending on the

current state. Pressing the "\*" key will toggle the state. Press the "CLR" key to return to "Force Vend". Press the "CLR" key to return to "SERVICE MODE" or press the "A" key to advance to the next menu item below.

### **SET TEMPERATURE SCALE**- Press key "6"

Allows the service technician to change the scale of the temperature in the vender to read in Fahrenheit or Celsius as needed. Press the number "6" on the keypad and the display will show "Set Temperature". Press the "\*" key and the display will show "Set Temperature Unit Degrees F (or C)". Press the C to display in Celsius or F to display in Fahrenheit. Press \* to save and display will return to "Set Temperature". Press the "CLR" key to return to "SERVICE MODE" or press the "A" key to advance to the next menu item below.

### **SET PRICES** - Press key "7"

To set the prices enter the "SERVICE MODE" by opening the service door and pressing the Service Button once. Allows the setting of regular and secondary prices for an individual item, a complete tray, or the entire machine. Factory setting is \$99.95. Press the number "7" on the keypad and the display will show "SET PRICE". Press the "\*" key and the display will show "1 = Regular Pricing, 2 = Secondary Pricing". To set regular prices press number 1 key and display will show "Regular \$##.##". To set price:

1. **All selections.** Press the keypad numbers of the price you wish to use. As numbers are entered the numbers will shift in from the right as they are entered. Note: The CLR key will remove the last # of the price. Once the desired price is showing on the display press the "\*" key and the display will show "PR\$##.## All Set", press "\*" to enter more prices or CLR to exit to SET PRICE.
2. **One tray.** Press the keypad numbers of the price you wish to use. As numbers are entered the numbers will shift in from the right as they are entered. Note: The CLR key will remove the last # of the price. Once the desired price is showing on the display press the tray letter desired for setting price. Press "\*" and display will show "PR \$##.## B(tray letter) Row Set", press "\*" to set more prices or CLR to exit to SET PRICE.
3. **Single selection.** Press the keypad numbers of the price you wish to use. As numbers are entered the numbers will shift in from the right as they are entered. Note: The CLR key will remove the last # of the price. Once the desired price is showing on the display press the selection desired for setting price. Press "\*" and display will show "PR \$##.## B1 Selection Set", press

“\*” to set more prices or CLR to exit to SET PRICE.

The last price entered for a selection is the one that is used. For example, If one price on the A tray was set to \$1.50 using option 3 above and you wish to change the remaining selections on that tray using option 2, the pricing for the entire tray would take precedence. Conversely, if the price was set using option 2 first followed by the single selection using option 3, the pricing for the remainder of the shelf would remain and the new price for the single selection would change to the new value. Press the “CLR” key to return to “Set Prices”. Press the “CLR” key to return to “SERVICE MODE” or press the “A” key to advance to the next menu item below.

### **SET SHELF LOCATION - Key “8”**

Allows the service technician to program the electronics to match the six different settings available for the shelves. These settings are available to vend different package heights. The factory default setting is Shelf Setting G. Press the number “8” on the keypad and display will show “Set Shelf Location”. Press the “\*” key and display will show current setting. To change the setting press one of the following: A = G setting, B = M1 setting, C = M2 setting, D = D setting, E = E1 setting, F = E2 setting. Note G, M1, & M2 settings are used in venders prior to 0001-8487AE and D, E1, & E2 settings are used in venders 0001-8487AE & higher. Once the desired setting is showing on the display press the “\*” key to save the setting. Note: all shelf settings have to be physically set to match the programmed setting. You can not set the physical shelf settings differently. Press the “CLR” key to return to “Set Shelf Location”. Press the “CLR” key to return to “SERVICE MODE” or press the “A” key to advance to the next menu item below.

### **RELAY TOGGLE - Press key “9”**

Allows the service technician to test the Light Relay, Fan Relay, and Compressor Relay. Press the number “9” on the keypad and the display will show “Relay Toggle”. Press the \* Key and display will show “Light A – On or Off”, “Fan B – On or Off”, “Compressor C – On or Off”. Display will show current status of the relay (not the component the relay operates). To toggle the state of a given relay press the letter key associated with it on the display. Caution: Disconnect power to the compressor before testing the compressor relay. Failure to disconnect power to the compressor before testing the relay could result in damaging the compressor. Press the “CLR” key to return to “Relay Toggle”. Press the “CLR” key to return to “SERVICE MODE” or press the “A” key to advance to the next menu item below.

### **CLEAR ERRORS - Press key “0”**

Allows the service technician to clear errors recorded in the venders data. Press the number “0”

Key and the display will show “CLEAR ERRORS”, then press \* Key and the display will show “Clear All Errors? \* = Y CLR = N”. Press the “CLR” key to return to “Clear Errors”. Press \* Key to clear all errors or press the “CLR” key to return to “SERVICE MODE”.

## **TEST MODE**

Enter TEST MODE by opening the service door and pressing the blue Service button twice. The display will read “TEST MODE”.

**NEXT ITEM - Press key “A”**

### **LIST ERRORS - Press key “B”**

Allows the service technician to view a list of all recorded errors. Press the letter “B” on the keypad and the display will show “LIST ERRORS”, then change to “NONE” if no errors exist or, if errors are present, one of the error prompts below will be displayed. If an error code is displayed, press the “\*” key to view the next error until “END LIST” is displayed. With “END LIST” showing on the display, press the “\*” key to clear errors and return to TEST MODE. If you wish to exit the list without clearing errors, simply push the “CLR” key and the display will return to LIST ERRORS. If the CLR key is pressed prior to reaching the end of the list, the display will jump to END LIST. Explanations for the error codes are listed below. Note: The prompts listed will only show on the display if an error has occurred.

**NONE** No errors have occurred.

### **VEND MECH ERROR**

**HORIZ** – Horizontal Drive System problem.  
**VERT** – Vertical Drive System problem.  
**PICKI** – Picker not all the way in problem.  
**PICKO** – Picker out switch error problem.  
**PORT** – Port Drive System problem.  
**VS** – Vend Sensor problem.

### **VMC ERRORS**

**FRAM** – Memory module read/write error.  
**RTC** – RTC read/write error, clock error.  
**SF** – Decimal error.  
**RCRC** – software not loaded properly.  
**LB** – Low battery.  
**PWR OUT** – Power lost.

### **KEYPAD ERROR**

**KEYPAD** – Keypad not installed.

### **COIN MECH ERROR**

**CC** – Coin Mech disconnected.  
**TS** – Tube Sensor defective.  
**IC** – No coin accepted for 96 hours (4 days).  
**TJXX** – Tube jam.  
**CRCH** – Check sum.

**EE** – Excessive escrow pressed (255 times between coin arrivals).

**NJ** – Coin jam.

**LA** – Low acceptance count.

**DIS** – Acceptor unplugged.

**ROUT** – Coin routing error.

#### **NOTE ACCEPTOR ERROR**

**BC** – Note Acceptor disconnected.

**BFUL** – Stacker full.

**BILL** – Defective motor.

**BJ** – Validator jammed.

**BRCH** – ROM checksum error.

**BOPN** – Stacker out of position.

**BS** – Sensor problem.

#### **CARD READER ERROR**

**CRC** – Card reader disconnected.

#### **REFRIG ERROR**

**SENS** – Temperature sensor problem.

**COLD** – Temperature to cold.

**HOT** – Temperature to hot.

**CMPR** – Compressor not cooling.

**HEALTH** – Health Guard error.

**END LIST** Indicates you have scrolled through the list of all present errors. Press the “CLR” key and display will change to “OK” and the display will change to “NONE”. Press the “CLR” key to return to “TEST MODE”, or the “A” key to proceed to “SELF TEST”

**NOT USED** - Press key “C” (NOT AVAILABLE)

**NOT USED** - Press key “D” (NOT AVAILABLE)

**KEYPAD TEST** - Press key “E”

Allows the service technician to test any or all keypad keys. Press the letter “E” on the keypad and the display will show “KEYPAD TEST”. Press the “\*” key and the display will show “Keypad Test”, then press each key on the keypad. Each key pressed will show on the display until the “CLR” key is pressed. The display will return to “Keypad Test”. Press the “CLR” key to return to “TEST MODE” or press the “A” key to advance to the next menu item below.

**FACTORY DIAGNOSTICS** - Press key “F”

Allows the service technician to test the XY and Cup port operations. The following are available in the test menu: 1 = Position Test, 2 = Port Test, 3 = currently not used, 4 = Repeat Vend, 5 = Vend Error Codes, 6 = Use Port Sensor, 7 = Turns off vend mech for software test, 8 = Adjust shelf offset. To enter the available modes press the “F” Key on the keypad and display will show “FACTORY DIAGNOSTICS”. Press the “\*” key and the display will show “1 = Position Test, 2 = Port Test”. Press the key # you wish to enter. Note: In early software revisions Port Test was 4, Repeat Test was 2, &

Shelf Offset was 8. Below is current programming as of 1/16/06.

1. Position Test. Note: The top door switch must be pulled to the out position to perform this test. **Caution: XY needs to be in the home position before performing this test.** If you look at the control board the green, amber (yellow), and red lights should be on at this time. If not please check the following: Green light is for home switch on bottom of port cup, amber light is for home switch on left side of Y motor assembly, red light is for home switch for picker cup plunger. Press the number 1 key and the display will show a set of numbers (ie ##### ###### #). To position test press the following:
  - a. Shelf letter (A,B,C,D,E) to travel to selected shelf.
  - b. Column number (1,2,3,4,5,6,7,8, & 9) to travel to selected column.
  - c. Key “0” to cycle cup plunger to hit column target.
  - d. Key “F” to return cup to home position.
  - e. Key “\*” is all stop.
2. Port Test. Press the number 2 key and the display will show four numbers “####”. The 1<sup>st</sup> # is Port Open switch and 0 = Port not open or 1 = Port opened. The 2<sup>nd</sup> # is Port Closed switch and 0 = Port not closed or 1 Port closed. The 3<sup>rd</sup> # is Sensor and 1 = Sensor on or 0 = Sensor off. The 4<sup>th</sup> # is Vend detect (only if Sensor is on) 0 = No product in port or 1 Product in port. To test the port press the following:
  - a. Key “A” to open port.
  - b. Key “B” to close port.
  - c. Key “C” to turn sensor on. When turned on and something is placed in the port a red LED will light on the board.
  - d. Key “D” to turn sensor off.
  - e. Key “E” to toggle Cup LED light.
  - f. Key “F” to toggle Port LED light.
  - g. Key “\*” All Stop on any of these tests.
3. Currently not used
4. Repeat Vend. Press the number 4 key and the display will show “Current Vend: #####” and start auto test vending each column. Press the “CLR” key to stop the test
5. Vend Error Codes – Caution: Factory Use Only do not use.
6. Use Port Sensor. Press the number 6 key and display will show current status.



Factory default is On. To toggle to Off/On press the “\*” key.

7. Turns off vend mech for software test. Caution: Factory use only for peripheral testing, do not use.
8. Adjust Shelf Offset. Press the number 8 key and the display will show “Shelf Offset 9200, 3310 counts = 1 inch”. This is the factory default. To change the offset enter a new number and press the “\*” key to save and display will show “##### Offset recorded. Then press “CLR” to go back to “Factory Diagnostics”. Go back to Position Test and check the plunger is contacting the targets correctly.

Press the “CLR” key to return to “Factory Diagnostics”. Press the “CLR” key to return to “TEST MODE” or press the “A” key to advance to the next menu item below.

### **TUBE FILL/DISPENSE - Press key “1”**

Allows the service technician to inventory currency in the coin mechanism escrow tubes and “Teach” the controller how many coins of each denomination are in that inventory. This allows for the maximum number of dollar bills to be accepted prior to enabling the “USE EXACT CHANGE” function. This also provides for exact cash accountability in the audit functions. This function can also be used as a diagnostic tool to insure the coin mechanism is responding properly. Press the number “1” on the keypad and the display will read ‘TUBEFILL/DISPENSE’.. Press the “\*” key and the display will show the lowest denomination accepted and the number of these coins inventoried. Press the letter “A” on the keypad to show through the denominations available. With a given denomination displayed, an inserted coin of this denomination via the coin chute will increase the inventory shown. Note: When you insert any denomination the display will change to show the denomination inserted. To dispense: while in the tube fill/dispense mode go to the coin mech and press the coin mech dispense button(s) for the tube you wish to dispense from or press the \* Key and the denomination displayed will be dispensed to the coin cup and the inventory will be decreased. Press the “\*” Key again to stop the coins from being dispensed. Press the “CLR” key to return to “Tube Fill/Dispense”. Press the “CLR” key to return to “TEST MODE” or press the “A” key to advance to the next menu item below.

### **DAYLIGHT SAVINGS TIME - Press key “2”**

Allows the service technician to enable daylight savings time to be set as it applies to the selected Daylight Savings Rules Setting. Press the “\*” key to show the current setting. Press the “A” key to scroll through the different settings that are

available. With the setting you wish to use showing on the display, press the “\*” key.

- OFF – No Daylight Savings Time
- American Rules. If enabled, the VCU will set the clock back one hour on the last Sunday of October (2:00 AM), set the clock ahead one hour on the first Sunday in April (2:00 AM).
- European Rules. If enabled, the VCU will set the clock back one hour on the last Sunday of October (1:00 AM), set the clock ahead one hour on the last Sunday in March (1:00 AM).
- Australian Rules. If enabled, the VCU will set the clock back one hour on the last Sunday of March (1:00 AM), set the clock ahead one hour on the first Sunday in October (1:00 AM).

Press the “CLR” key to return to “Daylight Savings Time”. Press the “CLR” key to return to “TEST MODE” or press the “A” key to advance to the next menu item below.

### **NOT AVAILABLE MODE - Press key “3”**

This setting works in conjunction with the “SET NOT AVAILABLE TIME” (option 3 in Setup Mode 1). This setting must be showing “Not Available # On” in order for the Not Available times to function as programmed. This mode can also be used to manually disable the times established in ‘NOT AVAILABLE TIME’ mode as long as the function is set to “Not Available # Off”. Press the number “3” on the keypad and the display will show “NOT AVAILABLE MODE”. Press the \* Key and display will show “Select Block (1 – 4). Press the select block group you wish to enter. Display will show “Not Available #: On (Off) Press \* turn off (on) to change the status. Factory default for this setting is Off. Pressing the “\*” key will toggle the state and set the controller to the new condition shown on the display (pushing the \* key with ON on the display will ALLOW the not available mode to function as programmed). Press the “CLR” key to return to “Not Available Mode”. Press the “CLR” key to return to “TEST MODE” or press the “A” key to advance to the next menu item below.

### **CREDIT TIMER MODE - Press key “4”**

Allows the service technician to set the vender to cancel a credit or keep a credit showing on the display after 5 minutes. Press the number “4” on the keypad and the display will show “CREDIT TIMER MODE”. Press the \* Key and the display will show “Credit Timer: Off (On) Press \* - turn On (Off). “Credit Timer Off” will save a credit indefinitely. “Credit Timer On” will only save a credit for five minutes. Press the “CLR” key to return to “Credit Timer Mode”. Press the “CLR” key to return to

"TEST MODE" or press the "A" key to advance to the next menu item below.

### **DOOR OPEN** - Press key "5"

Shows number of times the service door has been opened since last "CLEAR TOTALS" or "MASTER RESET". Press the number "5" on the keypad and "DOOR OPEN" will show on the display. Press the \* Key and "Door Opened # Times ##:## ## Month YEAR" will show on display. This is the number of times the service door has been opened since the last "CLEAR TOTALS" or "MASTER RESET" and the time, day, and date of the last opening. Press Key "A" to see the time of the 5 previous openings. Press the "CLR" key to return to "Door Open". Press the "CLR" key to return to "TEST MODE" or press the "A" key to advance to the next menu item below.

### **POWER OUT** - Press key "6"

Shows the number of times the machine has lost power since last "CLEAR TOTALS" or "MASTER RESET". (This is a power outage for any reason including the machine being unplugged or the machine's master power switch being turned off). Press the number "6" on the keypad and "POWER OUT" will show on the display, press the \* Key and "Power Lost # Times will show on the display and the date and time of the last outage which is the number of times power has been lost to the control board since the last "CLEAR TOTALS" or "MASTER RESET". Press Key "A" to see the time of the 5 previous outages Press the "CLR" key to return to "Power Out". Press the "CLR" key to return to "TEST MODE" or press the "A" key to advance to the next menu item below.

### **TEST HEALTH GUARD** - Press key "7"

This setting is in place to test the functioning of the health guard system by simulating a Health Code Error. Once activated, any selections programmed in "HEALTH CONTROL MODE" in the Setup Mode 1 will be disabled. To test health guard, press the number 7 on the keypad and the display will show "TEST HEALTH GUARD". Push the "\*" key and the display will change to "Test Health Guard? \* = Y CLR = N. Press \* and display will show Health Guard" then change to "Activated". The display will then return to "TEST HEALTH GUARD". Within one minute of returning the vender to service, items that were turned on in "HEALTH CONTROL MODE" setting in SETUP MODE 1 will be put out of service. Additionally, a "HEALTH" error will be displayed in 'LIST ERRORS'. Errors must be cleared before programmed items can be returned to service. Press the "CLR" key to return to "Test Health Guard". Press the "CLR" key to return to "TEST MODE" or press the "A" key to advance to the next menu item below.

### **DISPLAY HEALTH GUARD** - Press key "8"

Allows the service technician to view the selections that are listed under the "HEALTH CONTROL MODE" in the SETUP MODE 1. Press the number "8" on the keypad and the display will read "DISPLAY HEALTH GUARD". Press the "\*" key and the selection(s) that are listed under the health control will be displayed or "NONE ASSIGNED" if no selections are listed. Press the "\*" key to continue. Press the "CLR" key to return to "Display Health Guard". Press the "CLR" key to return to "TEST MODE" or press the "A" key to advance to the next menu item below.

### **TEST VEND** - Press key "9"

Allows the service technician to test vend any item. The service door must be closed or open all the way so the discharge door does not hit the delivery cup during the test vend process. You will need to catch the product if you test with door open. Press the number "9" on the keypad and the display will read "TEST VEND". Pull the top door switch in service door area to the out position for this test to work. Press the "\*" key and the display will read "ENTER SELECTION", you may close and lock door at this point if you wish to test with door closed. Select the item/column to be tested by pressing the corresponding keys on the keypad (i.e. A6), then press the \* Key to start the test vend, and the corresponding vend cycle will occur. Press the "CLR" key to return to "Test Vend". Press the "CLR" key to return to "TEST MODE" or press the "A" key to advance to the next menu item below.

### **SHOW CHECKSUMS** - Press key "0"

This function is used by Factory Engineers only.

## **SETUP MODE 1**

Enter SETUP MODE 1 by opening service door and pressing the Service button three times. The display will read "SETUP MODE 1". NOTE: Several areas in SETUP MODE 1 are password protected. When entry into one of these areas is attempted the display will read "Password" if a password has been entered in SETUP MODE 1. The password must be entered at this point before the service technician is allowed to proceed. The password need only be entered once during a service call provided the service door is not closed. If the door is closed and then re-opened, the password must be entered again before accessing a protected area. The factory default password is 0000. If the password is set at 0000 you will not be required to enter a password to access password protected modes. The display will show \*'s as the password is entered. When the last character is entered, the

display will read "OK", and then will shift into the requested area. If the display reads "BAD" after the last character is entered this means the password was not accepted.

**NEXT ITEM** - Press key "A"

**ENTER MESSAGE** - Press key "B"

(PASSWORD REQUIRED)

Allows the entry of a custom idle message to replace the default idle message. Press the letter "B" on the keypad and "ENTER MESSAGE" will show on the display. Press the "\*" key and "Edit Idle Message Enjoy a Refreshing Drink" will show on display with the first character on the left highlighted. The program is now ready to accept the new message. The "A" key will move forward through the alphabet, numbers, space, punctuation marks, \$, AND a "L". The "B" key will move backwards through the same list. When the desired character is displayed, press the "\*" key. That character is now entered and the display moves to the right one space as the new message is built. Press \* with the curser showing "{" and the curser will back up one space. Press the \* Key with the curser showing "I" will clear all characters to the right of the curser. When the new message is complete, press the "CLR" key and return to "Enter Message". Press the "CLR" key to return to "SETUP MODE 1" or press the "A" key to advance to the next menu item below.

**CLEAR MESSAGE** - Press key "C"

(PASSWORD REQUIRED)

Allows the service technician to clear any custom idle message and return to the default idle message. Press the letter "C" on the keypad and the display will show "CLEAR MESSAGE". Press the "\*" key and the display will read "Clear Message? \* = Y CLR = N, pressing the \* Key will set idle message back to factory default and then will return to "Clear Message". Press the "CLR" key to return to "SETUP MODE 1" or press the "A" key to advance to the next menu item below.

**ENABLE/DISABLE \$** - Press key "D"

(PASSWORD REQUIRED)

Allows the service technician to remove the dollar sign (\$) from the display when a product price, customer credit, or change due is displayed. When enabled, the dollar sign will appear in the display; when disabled it will not appear. Press the letter "D" on the keypad; the display will show "ENABLE/DISABLE \$". Press the \* key and display will show "Dollar Sign: On (Off) Press \* - turn Off (On). Press the \* Key to toggle. Press the "CLR" key to return to "Enable/Disable \$". Press the "CLR"

key to return to "SETUP MODE 1" or press the "A" key to advance to the next menu item below.

**SET HAPPY HOUR TIME** - Press key "E"

(PASSWORD REQUIRED)

Allows the service technician to set times and days for Happy Hour operation. Press the letter "E" key and "SET HAPPY HOUR TIME" will show on the display. Press the \* Key again and Happy Hour start time, end time, and days of the week can now be programmed into the system. All times must be entered in military time format (24 hour clock). Setting Happy Hour is covered in detail in the "SET NOT AVAIL TIME" in the INITIAL PROGRAMMING section of this manual. Press the "CLR" key to return to "SETUP MODE 1".

**MASTER RESET** - Press key "F"

(PASSWORD REQUIRED)

Allows the service technician to restore factory defaults to the machine or reset the Controller Board's memory after installing a new EPROM. Since this feature resets interval sales data, care should be taken prior to using. Press the letter "F" on the keypad and "MASTER RESET" will show on the display. Press the "\*" key and the display will read "Master Reset Continue? \* = Y CLR = N. To reset press the \* Key and display will show "Resetting" then show software version and then the idle message will scroll. Press the "CLR Key to return to "Master Reset". Press the "CLR" key to return to "SETUP MODE 1" or press the "A" key to advance to the next menu item below. Please see table on next page for programming options effected by MASTER RESET. NOTE: A power out error message will be generated when a master reset is performed. The table outlines the results of using MASTER RESET.

ITEM	RESET TO
CASH BOX	\$0.00
SALES	\$0.00
NUMBER SOLD	0
SALES PER COLUMN	0
ESCROW	OFF
FORCE	OFF
SET REGULAR PRICES	99.95
SET HAPPY HOUR PRICES	99.95
LIST ERRORS	Pwr Out
TUBE FILL/DISPENSE	CLEARED
DAYLIGHT SAVINGS	OFF
NOT AVAILABLE	OFF
CREDIT TIMER	OFF
DOOR OPEN	0
POWER OUT	1
IDLE MESSAGE	RESET
ENABLE DOLLAR SIGN	ON

MACHINE NUMBER	UNCHANGED
SET HAPPY HOUR	CLEARED
NOT AVAILABLE TIME	CLEARED
HEALTH CONTROL	OFF
PASSWORD	0000
STS ENABLE	OFF
CUSTOM STS	CLEARED
NOVEND LIMIT	0
SOLD OUT	ENABLED
PRICE DISPLAY	ON
SHELF CONFIG	G
INTERVAL CLEARING	OFF
DISPLAY TEMPERATURE	ON
TEMPERATURE UNITS	DEG F
SERIAL #	UNCHANGED
LOCATION ID	UNCHANGED
CR ASSET #	UNCHANGED
NA ASSET #	UNCHANGED
CM ASSET #	UNCHANGED
SOLD OUT TIMES	CLEARED
DEX PASSWORD	000000
DOOR OPEN TIME	CLEARED
POWER OUT TIME	CURRENT TIME
STORAGE TEMP	57 DEG F
REFRIG TEMP	37 DEG F
CONSUMER OVERPAY	OFF

**MACHINE NUMBER** - Press key "1"

(PASSWORD REQUIRED)

Allows assigning a user number to the machine for audit and/or inventory control requirements. Press the number "1" on the keypad and "MACHINE NUMBER" will show across the display and then change to the number currently assigned to the machine (i.e. ID 1). Press the "\*" key and the display will read "ID". Enter the new number (numeric field, 4 characters maximum). If the new number is less than 4 characters press the "\*" key after entering it and the display will read "OK" momentarily and will return to "SETUP MODE". Press the "CLR Key to return to "Machine Number". Press the "CLR" key to return to "SETUP MODE 1" or press the "A" key to advance to the next menu item below.

**SET HAPPY HOUR** - Press key "2"

(PASSWORD REQUIRED)

Allows the service technician to turn Happy Hour ON or OFF. Press the number "2" on the keypad and "SET HAPPY HOUR" will show across the display. Happy Hour. Press the \* Key and display will show "Happy Hour: Off (On). Press \* - turn On (Off). Press the "CLR Key to return to "Set Happy Hour". Press the "CLR" key to return to "SETUP MODE 1" or press the "A" key to advance to the next menu item below.

**SET NOT AVAIL TIME** - Press key "3"

(PASSWORD REQUIRED)

Password protected. Before entering or changing this setting you must enter the password if one has been assigned. This mode allows up to 4 different time periods that use of the machine may be restricted. Refer to Initial Set Up section Set Not Available Times.

**CONSUMER OVERPAY** - Press key "4"

(PASSWORD REQUIRED)

Allows the service technician to set the machine up to allow consumer overpay to vend. This will allow a vend if there is not enough change in the mech to be paid to consumer. Factory default will be Off. Press the number "4" key and display will show "Consumer Overpay". Press \* Key and display will show "CONSUMER OVERPAY OFF (ON), Press \* - turn ON (OFF)" will show on the display. Press the "\*" Key to toggle setting and press CLR return to "Consumer Overpay". Press the "CLR" key to return to "SETUP MODE 1" or press the "A" key to advance to the next menu item below.

**DATE/TIME** - Press key "5"

Shows the year, month, date, and time setting currently in the system in following format: 2005 Apr 28 15:45. Setting the day, date, and time is covered in the INITIAL PROGRAMMING section of this manual. Press the "CLR" key to return to "SETUP MODE 1".

**TOTAL SALES** - Press key "6"

Shows total sales since machine manufacture. This total is not cleared by CLEAR TOTALS. Press the number "6" on the keypad, the display will show "TOTAL SALES" press the \* Key and "Sales: ### and Vend ### totals will show on display. Press the "CLR" key to return to "Total Sales". Press the "CLR" key to return to "SETUP MODE 1" or press the "A" key to advance to the next menu item below.

**HEALTH CONTROL** - Press key "7"

Allows the service technician to select items to ENABLE HEALTH CONTROL. When enabled, if the temperature in the vender does not reach 41 degrees F within 30 minutes after the service door is closed, a "HEALTH TIME" error will occur and lockout the enabled selection(s) from vending until after the error is cleared. Also, if the temperature in the vender goes above 41 degrees F for more than 15 minutes after the initial cool down period, a "HEALTH CONTROL" error will occur and lockout the enabled selection(s) from vending until the error is cleared. Press the number "7" on the keypad and the display will show "HEALTH CONTROL". Press the "\*" key and the display will show "ENTER SELECTION". To set:

1. **All selections.** Press the \* key and display will show "Disabled (Enabled) Continue? \* = Y CLR = N. When enabled

all selections in the vender will now be set for health control. Press CLR to show all selections assigned. Then press CLR and the display will change to "ENTER SELECTION". Press CLR to return to "HEALTH CONTROL".

2. **One tray.** Pressing the letter of the shelf followed by the \* key and display will show "Disabled (Enabled) Continue? \* = Y CLR = N. When enabled all selections on that shelf will now be set for health control. For example, to control the A shelf push key "A" followed by "\*" key. The display will change to "ENTER SELECTION". Press CLR to display all selections assigned then press CLR to return to "HEALTH CONTROL".
3. **Single selection.** Pressing the desired selection followed by the \* key and display will show "Disabled (Enabled) Continue? \* = Y CLR = N. When enabled desired selection will now be set for health control. For example, to control the A1 push keys "A1" followed by "\*" key. The display will show "Disabled (Enabled)" etc... Press CLR to display all selections assigned then press CLR to return to "HEALTH CONTROL".

Priority will be given to the higher ranked method. If one selection on the A tray was set to ENABLE using option 3 above and you wish to change the remaining selections on that tray using option 2, the Setting for the entire tray would take precedence. Conversely, if the tray was set using option 2 first followed by the single selection using option 3, the setting for the remainder of the shelf would remain and the new price for the single selection would change to the new value. Press "CLR" to return to "SETUP MODE".

### UPDATE SOFTWARE - Press key "8"

(PASSWORD REQUIRED)

Allows the service technician to manually load software if needed. New software automatically loads on power up. **Caution:** If this mode is entered with no eprom installed in controller, it will cause control board failure. The following information describes how to update software. All new software revisions will automatically update the software revision in the control board. **Important:** Eproms containing software are sensitive to Electrostatic Discharge (ESD). Failure to handle the Eprom carefully could cause damage, which may result in a failed control board. **ALWAYS KEEP THE EPROM IN THE ESD TUBE. GROUND YOURSELF ON THE VENDER CABINET BEFORE REMOVING THE EPROM FROM THE ESD TUBE OR CONTROL BOARD. AN EPROM CAN BE USED TO PROGRAM MANY VENDERS, AS LONG AS CARE IS TAKEN NOT TO DAMAGE THE**

**EPROMS LEGS. ALWAYS TURN POWER OFF BEFORE REMOVING OR INSTALLING EPROMS IN THE CONTROL BOARD.** Important Notes: Use the programming section of the manual to program the vender.

#### 1. EPROM Removal:

- a. Power down the Vender. Ground yourself on the vender cabinet before removing the EPROM from the ESD tube or control board.
- b. If an Eprom is present in the control board, remove the existing Eprom.
  - i. Note; An Eprom does not need to be in the control board after the control board has been programmed. The Eprom can be used to program other boards.
- c. Verify the pins of the new Eprom are not bent before installing in the Eprom socket.
- d. Install the new Eprom in the Eprom socket. Ensure the Eprom is oriented correctly with its reference marker (locator) in the same direction as the reference marker (locator) of the Eprom socket. Do not rely on the Eprom label for orientating the Eprom.

#### 2. Automatic Reprogramming:

- a. Turn power on to Vender. When auto-updating the display will show old version for a few seconds while the red LED on the control board blinks.
- b. Display will change to "EPROM UPGRADE..." for approximately 10 seconds with the green LED rapidly blinking.
- c. Display will change to new version software with red LED blinking at a steady heart beat rate.

#### 3. Manual Reprogramming (used if Eprom does not automatically reprogram):

- a. At power up, the current software version will be displayed. To manually program the control board with the new software, press the service switch on the control board to enter service menus. Advance to "UPDATE SOFTWARE". Press the \* Key. Display will show "Reprogramming Vendor" while the yellow LED blinks.
- b. Display will show new software revision, then return to stand by. This confirms new software has been successfully updated.

Note: to remove the Eprom after programming, remove power to the vender, ground yourself on the

vender cabinet before removing the Eprom, remove the Eprom, while still grounded install a label on the microprocessor showing the revision of software that is installed in the controller, power the vender back on and test for proper operation.

### **SET LIGHTS OFF TIME** - Press key "9"

Allows the service technician to set times and days for Light operation. Press the number "9" key and "SET LIGHTS OFF TIME" will show across the display. Lights Off start time, end time, and days of the week can now be programmed into the system. All times must be entered in military time format (24 hour clock). Set Lights Off Time can be set the same way as Set Not Available Time in the Initial Programming section of the manual.

### **ENTER NEW PASSWORD** - Press key "0"

(PASSWORD REQUIRED)

Allows the service technician to enter a 4 number personalized password. IF YOU DECIDE TO CHANGE FROM THE DEFAULT PASSWORD, PLEASE ENTER THE NEW FOUR NUMBER PASSWORD SLOWLY AND CAREFULLY!!! Press the number "0" on the keypad and "ENTER PASSWORD" will show across the display. Press the "\*" key and the display will read "ENTER PASSWORD". Enter the new password, the display will show \* for each character Key pressed. Once new password is complete press \* Key to save. Display will show "Verify new password", press new password, then the \* Key. Display will show "Password recorded Continue? \* = Y CLR = N. Press the "CLR Key to return to "ENTER NEW PASSWORD". Press the "CLR" key to return to "SETUP MODE 1" or press the "A" key to advance to the next menu item below.

## **SETUP MODE 2**

Enter SETUP MODE 2 by opening the main door and pushing the Service button four times. The display will read "SETUP MODE 2"

### **NEXT ITEM** - Press key "A"

### **STS ENABLE/DISABLE** - Press key "B"

Turns Space-to-Sales Mode On and Off. When On, Space-to-Sales vends are performed according to the configurations defined using "DEFAULT STS" and/or "CUSTOM STS". Press the Letter "B" on the keypad. The display will show the current state of the Space-to Sales vend mode as "STS ON" OR "STS OFF". Press the \* Key, there are now two choices:

1. Press the "CLR" key to leave the Space-to-Sales vend mode unchanged and return to "SETUP MODE 2"

2. Press the "\*" key to toggle the state on or off. The display will show a new message indicating the updated state.

Press the "CLR Key to return to "STS ENABLE". Press the "CLR" key to return to "SETUP MODE 2" or press the "A" key to advance to the next menu item below.

### **CUSTOM STS** - Press key "C"

Configures the Vender Space-to-Sales according to what is set. Press the letter "C" on the keypad. The display will show "Custom STS". Press the \* Key and display will show "Enter Start Location".

1. Pressing the "\*" key will set STS to a one to one configuration such that each selection is mapped only to it's corresponding column.

**Note: This setting overrides any previously defined Space-to-Sales blocks.**

2. Pressing a tray selection followed by "\*" will configure an entire tray as a single Space-to-Sales block. Example is selections A1 through A9 vend from columns A1 through A9 sequentially.
3. Pressing an item selection (A1) will specify the first product of the Space-to-Sales block. After the first item is programmed, the display will change to "Enter end location". Press the item selection corresponding to the last item in the block. This option may transcend more than one shelf, i.e. A1 to B9.

In all of the above options, after a selection is made, Display will show "OK? \* = Y CLR = N. You must press \* at this prompt to save your setting. Press "CLR" at any time to return to SETUP MODE 2.

### **DEFAULT STS** - Press key "D"

Configures the Vender Space-to-Sales to the preset mappings. Press "D" on the keypad and the display will show "DEFAULT STS". Press the "\*" key to configure Space-to-Sales in preset blocks of three (A1 – A3, A4-A6, A7-A9, B1-B3,...). Display will show "Set Default STS? \* = Y CLR = N. You must press \* at this prompt to accept Default STS. Press "CLR" at any time to return to SETUP MODE 2.

### **DISPLAY STS** - Press key "E"

Allows verification of the Vender Space-to-Sales settings for an individual selection block. Press the letter "E" on the keypad. The display will show "DISPLAY STS". Press the "\*" key and the display will change to "ENTER SELECTION". Enter any selection item, press the \* Key, and the display will read "##-## ## Continue? \* = Y CLR = N. The first ## indicates the first column in the selection's block. The second ## indicates the last column in the selection's block. The last ## indicates the column that the next vend will come from in this STS block. For example, entering "A2" might display "A1-A3

A1, indicating that selection A2 is part of the block that spans between A1 and A3 and that A1 selection is next in line to be vended. Press "CLR" at any time to return to SETUP MODE 2.

### **SET NOVEND LIMIT – Press Key "F"**

If a Vend fails - either due to a vend error or no product detected in the recovery unit - and the drop sensor is enabled, the VMC will mark the column as sold out. If the Space-to-Sales is enabled, the product column will be removed from the Space-to-Sales rotation and the VMC will attempt to vend from the next column in the Space-to-Sales block. If the vender is unable to vend any products from a Space-to-Sales block, the customer's credit will be returned and the entire block will be marked as "SOLD OUT". Press the "F" key on the keypad. The display will show "SET NOVEND LIMIT". Press the "\*" key and the display will show "NOVEND LIMIT #". The value # is the current vend limit which is applied to each selection. When # is 0, no vend limits are enforced. Enter the desired vend limit and press the "\*" key to accept this value or press the "CLR" key to cancel changes and return to SETUP MODE 2. The NOVEND limit specifies the number of times a location can be vended empty before it is blocked as "Sold Out".

**MULTIVEND - Press key "1" (NOT AVAILABLE)**

**NOT USED - Press key "2" (NOT AVAILABLE)**

### **SOLD OUT ENABLED/DISABLED - Press key "3"**

Controls sold out detection by the port sensor. When "On", a signal is sent to the VCU when the port sensor does not detect a selected item. That signal tells the VCU that the item selected is sold out and removes it from the STS block until the next time the vender is serviced. Press the number "3" on the keypad. The display will show "SOLD OUT ENABLED (DISABLED)". Press the "\*" key and display will show "Use Port Sensor: Off (On), Press \* - turn On (Off). Press "CLR" to exit without making changes and return to "SOLD OUT ENABLE/DISABLE". Press "CLR" to return to "SETUP MODE 2".

### **PRICE DISPLAY - Key "4"**

This setting controls whether the vender displays a price when a selection is made. Machines with a card reader capable of displaying selection prices may be configured to prevent displaying prices on two separate displays. Press the number "4" on the keypad and display will show "Price Display". Press the \* Key and display will show "Price Display: On (Off). Press \* - turn Off (On). Press the \* Key to toggle or press the "CLR" key to exit without making

changes and return to "PRICE DISPLAY". Press "CLR" to return to "SETUP MODE 2".

### **STORAGE TEMP ENABLE/DISABLE –**

Press key "5"

Press key 5 and display will show current state "Storage Temp Enable (Disable). Press \* Key and display will show "Storage Temp On (Off). Press \* - turn Off (On). Press the \* Key to toggle or press the "CLR" key to exit without making changes and return to "STORAGE TEMP ENABLE/DISABLE". Press "CLR" to return to "SETUP MODE 2".

### **INTERVAL CLEARING – Press key "6"**

This function is used to indicate the state of the interval clearing setting. Press the number "6" key and "INTERVAL CLEARING" will show on display. Press the \* Key and display will show Interval Clear: Off (On). Press \* - turn On (Off). When turned "ON", the interval (resettable) data will automatically be cleared upon successful completion of a DEX audit. When turned "OFF" it allows for remote auditing devices that clear resettable data manually to be used to clear the data. Press the \* Key to toggle or press the "CLR" key to return to "INTERVAL CLEARING". Press "CLR" to return to "SETUP MODE 2".

### **SET LIGHTS OFF – Press key "7"**

The function is used to turn on the "SET LIGHTS OFF TIME" set in "SETUP MODE 1". Press the number "7" key and "SET LIGHTS OFF" will show on display. Press the "\*" Key and display will show "Lights Off: Off (On). Press \* - turn On (Off). Press the \* Key to toggle or press "CLR" to return to "SET LIGHTS OFF". Press "CLR" to return to "SETUP MODE 2".

### **SET REFRIGERATION TEMP – Press key "8"**

This is the same as "Set Refrigeration Temperature" in Service Mode section of manual.

### **SET STORAGE TIME – Press key "9" "**

This function is used set the Time, Date, and Day when Storage Temperature will be ON. Press the number "9" and "SET STORAGE TIME" will show across display. Set Storage Time can be set in the same manner as "SET NOT AVAIL TIME" covered in the Initial Programming Section of this manual.

### **SET STORAGE TEMP – Press key "0" "**

This function is used to set Storage Temperature. Press the number "0" key and "SET STORAGE TEMP" will show on display. Set Storage Temp can be set in the same manner as "SET TEMPERATURE" covered in "SERVICE MODE" section of this manual.

## General Maintenance

The most important facets of proper care and maintenance of your machine are the electrical power supplied to it, leveling, and cleanliness of the machine.

### **POWER**

The machine must be connected to a dedicated 120 VAC, 15 Amp circuit (U.S. and Canada).

#### **CAUTION:**

**REMOVE POWER TO THE AC DISTRIBUTION BOX BEFORE CLEANING OR WHEN ANY ELECTRICAL COMPONENTS ARE CONNECTED / DISCONNECTED FOR TESTING OR REPLACEMENT.**

### **CLEANING**

**DO NOT USE A WATER JET OR NOZZLE TO CLEAN THE VENDER**

### **GLASS DOOR**

The display glass should be cleaned inside and out with paper towels and glass or non-abrasive all-purpose cleaner. The gasket around the product door should be wiped down using warm water, any mild general purpose, non-abrasive cleaner and a soft towel. Never lubricate the gasket and always check for cracking or deformities which may cause leaks. Replace if necessary.

### **VERTICAL LAMP LENS COVER**

Then vertical lamp lens covers are of a polycarbonate material. Clean as needed with warm water only. Ammonia or alcohol based products will damage the lens cover.

### **TRAYS / TRAY INSERTS**

The trays and tray inserts should be cleaned periodically using warm water and a mild general purpose, non-abrasive cleaner. Care should be taken to ensure debris does not enter the gear box assemblies. **DO NOT USE SOLVENTS OR ABRASIVE MATERIALS TO CLEAN ANY PORTION OF THE TRAY.**

### **DOOR LIGHTING**

The machine is designed with an energy efficient T8 Lighting System. To ensure continued reliable operation, replace only with the same type and size lamps. Lamps must be properly installed and seated in the lamp holders.

### **SLIDE/PUSHER ASSEMBLY**

The slide/pusher assembly should be cleaned periodically using warm water and any mild

general-purpose non-abrasive cleaner. After drying, the slide assembly needs to have a coat of Armoral applied. Care should be taken to ensure debris does not enter the gear box assemblies. **DO NOT USE SOLVENTS OR ABRASIVE MATERIALS TO CLEAN ANY PORTION OF THE TRAY.**

### **CABINET**

Wash the cabinet with a good detergent or soap mixed in warm water. Wax the vender often with a good grade of automobile wax. Any corrosion inside the vender should be removed with fine steel wool and the area should be painted with white paint.

Repair any scratches on painted surfaces to prevent corrosion.

### **DRAIN PAN, DRAIN TUBE, AND DRAIN HOSE**

To prevent mold and mildew growth, and to avoid personal injury or property damage, the drain pan, drain tube, and drain hose must be properly aligned and routed. Ensure nothing obstructs the drain tube or drain hose and that the hose is not bent, pinched, or twisted in such a way as to prevent the flow of condensate. Periodically inspect the drain pan, drain tube, and drain hose for alignment and the presence of dirt, debris, mold, and mildew. Clean as needed.



### **WARNING**

**THE COMPRESSOR ELECTRICAL CIRCUIT IS ALWAYS LIVE WHEN THE PLUG IS CONNECTED TO AN ELECTRICAL OUTLET.**

### **REFRIGERATION CONDENSER**

Clean the condenser periodically of dirt or lint build-up. Remove the build up with a brush or vacuum, or blow the dirt out of the condenser with compressed air and approved safety nozzle. Ensure nothing obstructs air intake at the bottom of the main door. Ensure nothing obstructs air exhaust at the rear of the cabinet.

### **COIN ACCEPTOR**

Follow the Coin Acceptor Manufacturer's instructions.

### **LUBRICATING THE VENDER**

The vender refrigeration system does not require any field lubrication. The hermetic refrigeration system and fan motors are manufactured with lifetime lubrication.



## AC DISTRIBUTION BOX

Bev Max 2  
110 VAC units

Main Power Switch / Plug	Interrupts hot side of incoming power to all components in machine.
15 Amp Outlet (110 VAC)	Provides power to refrigeration unit.
Transformer (T1)	Provides 24 Volt and 12 Volt (center tap) power to the Controller Board.
Fuse (Center)	Is not used. Note: It is installed in domestic units only but is not used.
Fuse (Left)	10 Amp, 32 Volt, SloBlo; protects 24 Volt input to Controller Board from secondary of T1.
Fuse (Right)	1.25 Amp, SloBlo; protects 12 Volt input to Controller Board from secondary, center tap of T1.

Varistor Across incoming AC power to remove large power spikes.

## Service Door Switches

Top or Left Switch – in XY Motor Circuits, Port Door Motor Circuit, and Picker Motor Circuit. (Power Interrupt)

Bottom or Right Switch – in Controller and Electronic Lock Circuit.

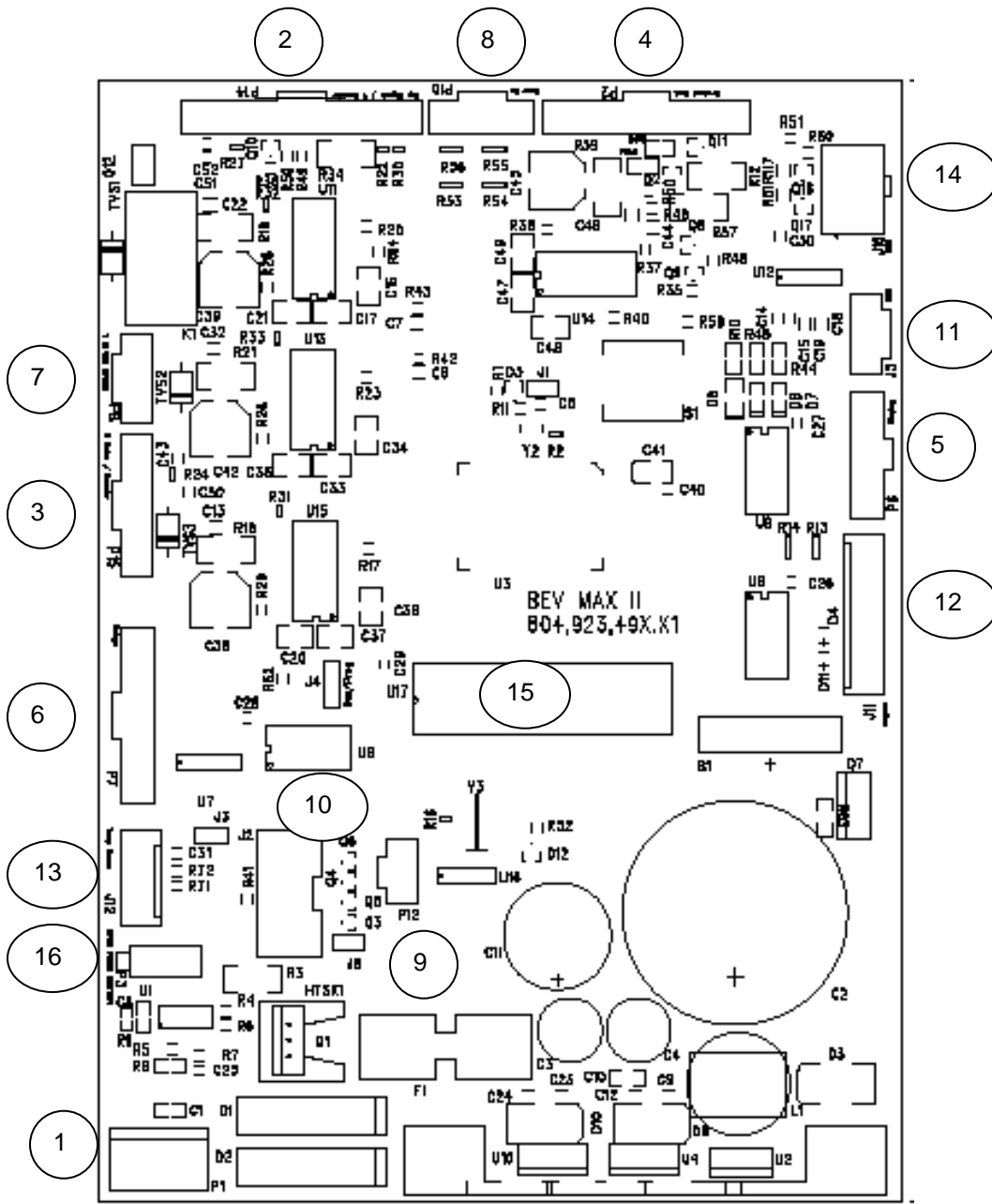

BEV MAX 2 MDB CONTROLLER CONNECTIONS

ITEM	CONNECTION	DESCRIPTION	ITEM	CONNECTION	DESCRIPTION
1	P1	Power from AC Distribution Box	9	P12	Not Used
2	P14	Cup Signal & Y Encoder	10	J2	Not Used
3	P15	X Motor & Encoder	11	J5	DEX
4	P2	Product Port	12	J11	Keypad
5	P6	Display	13	J12	Temp Sensor
6	P7	Relays	14	J16	Multi Drop Bus
7	P8	Y & Cup Motors	15	U17	EPROM Socket
8	P10	Door Switch	16	P3	Door Switch XY

## BEV MAX 2 TROUBLESHOOTING “XY” ISSUES

1. Selection will not vend.
  - a. Does a different selection vend?
    - i. Perform TEST VEND in TEST MENU ensure proper selection vends.
    - ii. Check Custom Space-To-Sales has been enabled.
      1. Check STS configuration in SETUP MODE 2 Menu.
  - b. Did the gate actuate at all?
    - i. Plunger cycled but gate but did not fully actuate.
      1. Gate Sticking.
        - a. Check plunger to target alignment in position test.
        - b. Shuttle bad.
        - c. Bent pins.
        - d. Check gear box & follower.
      2. Possible delivery cup assembly position alignment problem
        - a. Plunger should hit approximately ¼” from top edge of target.
          - i. Adjust shelf offset see programming “Test Vend/Position Test”.
        - b. Perform vend test on selections.
          - i. Only occurs on one column.
            1. Defective target.
            2. Defective gear box.
            3. Defective follower.
          - ii. Occurs on entire shelf.
            1. Shelf not secured on supports.
            2. Position alignment.
          - iii. Occurs on same column, multiple shelves (A2, B2, C2, D2, E2).
            1. Shelf not secured on supports.
            2. Position alignment.
        3. Plunger did not cycle fully.
          - a. Replace delivery cup assembly.
          - b. Replace control board.
      - ii. Gate did actuate
        1. Product and gate mismatch.
        2. Possible delivery cup assembly position alignment problem
          - a. Plunger should hit approximately ¼” from top edge of target.
            - i. Adjust position alignment see programming “Test Vend/Position Test”.
          - b. Perform vend test on selections.
            - i. Only occurs on one column.
              1. Defective target.
              2. Defective gear box.
              3. Defective follower.
          3. Dirty / worn tray slide with pusher.
            - a. Check slide with pusher.
    2. Delivery Cup Assembly Plunger Issues.
      - a. Plunger jam/dry vend.
        - i. Syrup/dirt causing plunger to stick.
        - ii. Replace delivery cup assembly.
        - iii. Replace control board.
          1. Software did not attempt to vend

- a. Check error list. Does error list show “VEND ERR”, with selection included in vend error list when pressing “A”?
      - b. A previous vend operation or vend test failed.
    - 2. Software has selection identified as “sold out”.
    - 3. Selection is placed under SETUP MODE, HEALTH GUARD.
    - 4. Selection is placed under SERVICE MODE, SET COOL DOWN function.
    - 5. Selection has been disabled through SERVICE MODE, ENABLE ITEM function.
  - b. Plunger Hits Chassis.
    - i. Check tray is level and secured to tray supports.
    - ii. Check harness connections.
    - iii. Check X motor (bottom right).
    - iv. Check current software is being used 804,924,080.01.
  - c. Plunger Stays Out.
    - i. Check for syrup or dirt build up.
    - ii. Check Harness connections.
    - iii. Check current software is being used 804,924,080.01.
- 3. Delivery Cup Assembly Will Not Go Home.
  - a. Is there a “Vend Error” on the display?
    - i. If yes check the “Y” (lower) and “X” (top far left) home switches.
      - 1. In Test Vend/Position Test with the top door switch pulled out:
        - a. At the home position the “Y” (lower) home switch will light a green LED on the control board.
        - b. At the home position the “X” (top far left) home switch will light an amber LED on the control board.
          - i. Adjust the X drive belt at the bottom left belt clamp.
  - b. Check dynamic tensioner.
    - i. On rear belt it should be 6” from the bottom.
    - ii. If one is installed on the front belt it should be 6” from the top.
- 4. Elevator will not move vertically.
  - a. Perform TEST VEND/POSITION TEST in TEST MENU to test movement.
  - b. Check top door switch.
    - i. Is it functioning.
    - ii. Is it being made when door is closed.
  - c. Check the Delivery Cup Plunger & Plunger Home Switch.
    - i. If plunger arm is stuck out it will shut down XY delivery system.
    - ii. If plunger arm home switch fails it will shut down XY delivery system.
  - d. Check the 10 pin harness connector to the “Y” motor.
  - e. Check rollers.
  - f. Check harness and motor.
  - g. Replace control board.
- 5. Elevator will not move horizontally.
  - a. Perform TEST VEND/POSITION TEST in TEST MENU to test movement.
  - b. Check top door switch
    - i. Is it functioning.
    - ii. Is it being made when door is shut.
  - c. Check the lower and top far left home switches.
    - i. In Test Vend/Position Test with the top door switch pulled out:
      - 1. At the home position the “Y” (lower) home switch will light a green LED on the control board.

2. At the home position the “X” (top far left) home switch will light an amber LED on the control board.
      - a. Adjust the X drive belt.
    - d. Check the Delivery Cup Plunger & Plunger Home Switch
      - i. If plunger arm is stuck out it will shut down XY delivery system.
      - ii. If plunger arm home switch fails it will shut down XY delivery system.
    - e. Check rollers.
    - f. Check harness and motor.
    - g. Replace control board.
6. Product Will Not Load From Delivery Cup Assembly To Port Assembly.
  - a. Perform TEST VEND/POSITION TEST in TEST MENU to test movement.
  - b. Check current software is being used 804,924,080.01.
  - c. Check belt tension.
  - d. Check Service Wall Port Door Assembly is securely installed.
7. Port Assembly On Service Door Will Not Open.
  - a. Perform TEST VEND/POSITION TEST in TEST MENU to test movement.
    - i. Port open will light the Amber LED on control board
    - ii. Port closed will light the Green LED on control board
  - b. Check fuse 1 by door switch in service area.
  - c. Check for syrup or dirt build up.
  - d. Replace port assembly.
  - e. Check harness and motor.
  - f. Replace control board.
8. Double Vend From Gate
  - a. Is correct gate assembly used in early models.
    - i. Small diameter cans may only be vended from tray A in early models.
    - ii. Large diameter packages may not be vended from tray A in early models.
  - b. Too many packages loaded in column.
9. Package Not Sliding On Slide Assembly.
  - a. Vender not level.
  - b. Slide not installed correctly.
  - c. Slide dirty. Clean and apply Armoral or Food Grade Silicone.
10. Delivery Cup Assembly Caught On Tray
  - a. Check vender is level.
  - b. Check rollers.

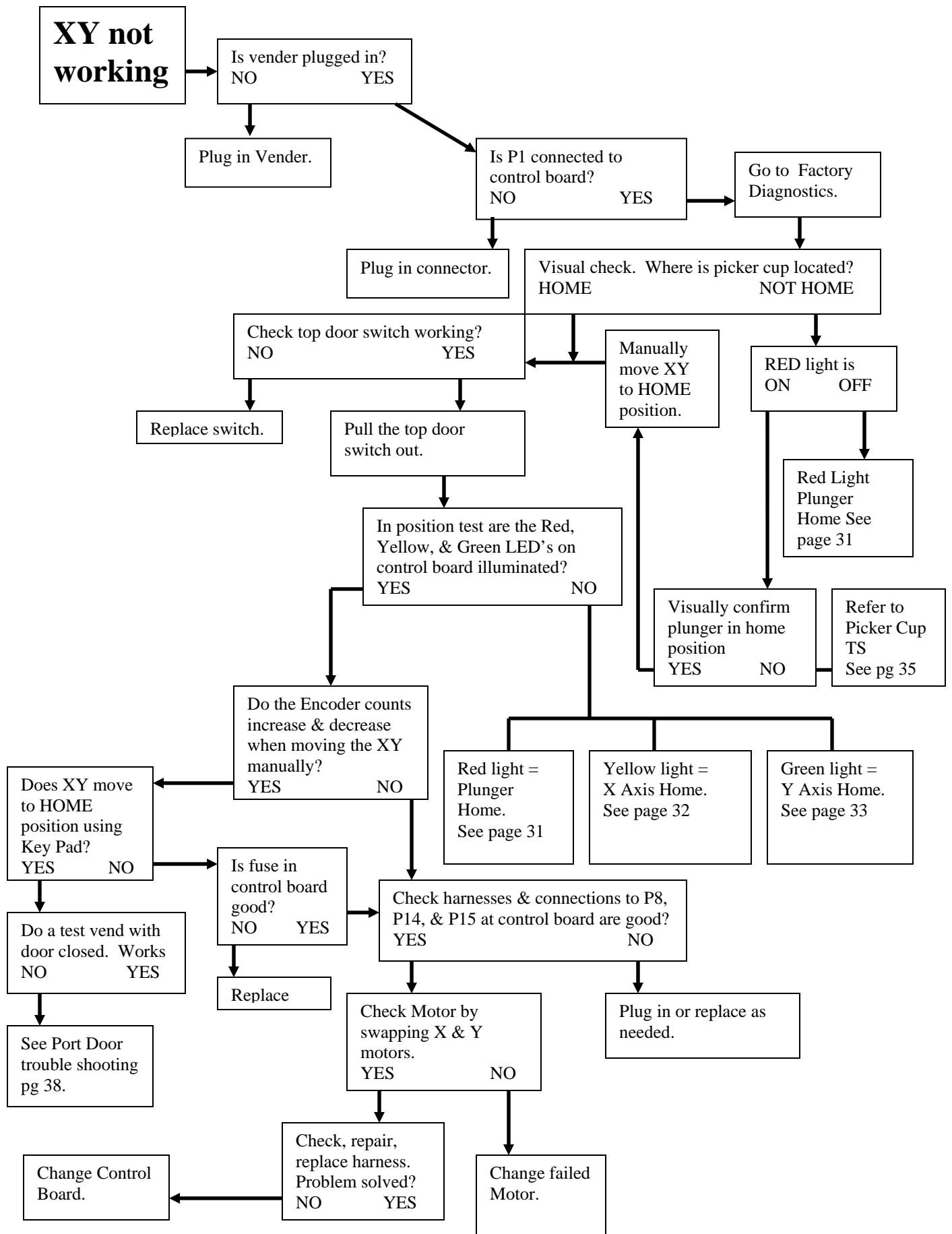

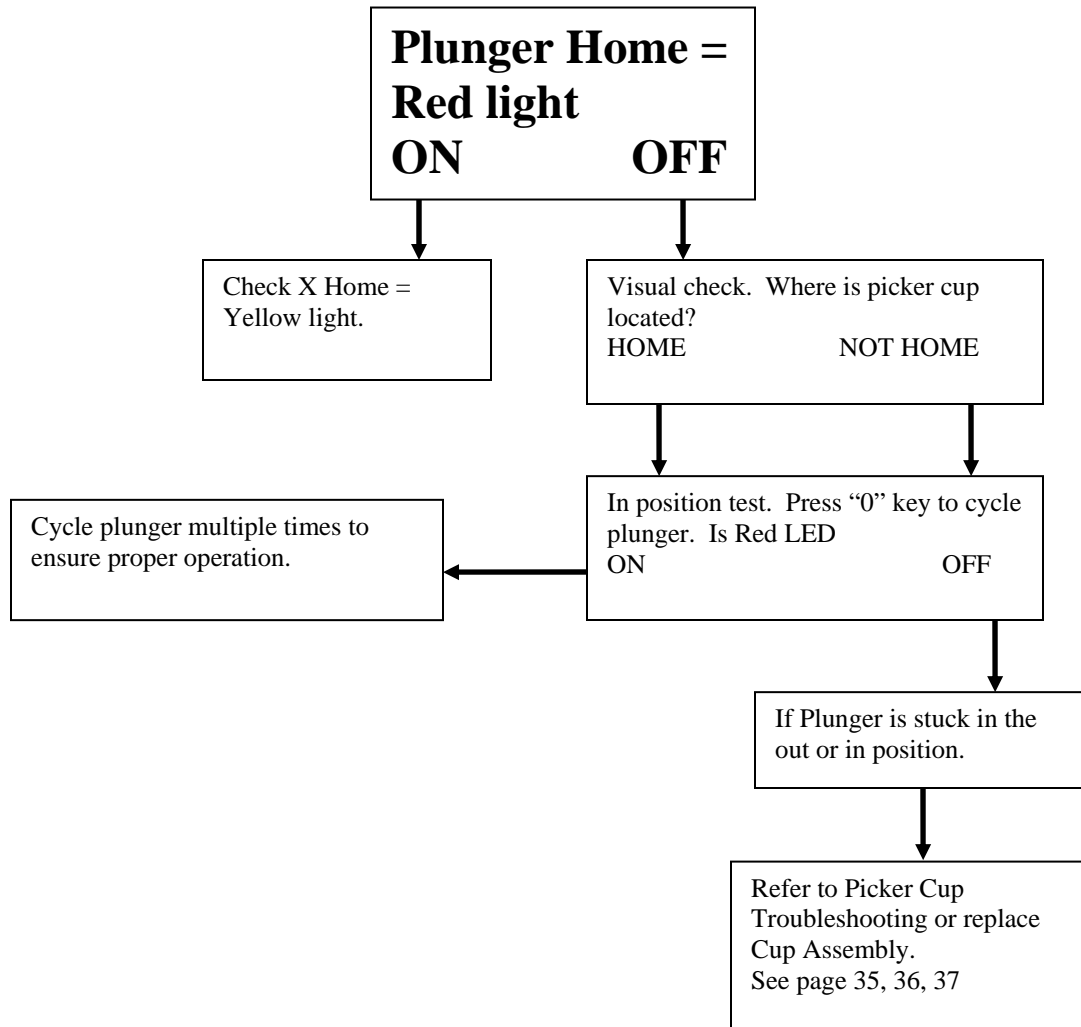

**X Axis Home =  
Yellow light  
ON            OFF**

Check Y Home =  
Green Light

Manually activate the switch  
and light cycles on and off.  
YES            NO

Manually move cup to A9 and  
pull top door switch out.

Check, repair, or replace switch  
or harness. Problem solved?  
YES            NO

Press the "F" key. Picker Cup  
goes to the home position?  
YES            NO

Do a Vend  
Test with  
Door Closed.

Is the Yellow  
LED on?  
YES            NO

Does motor run?  
YES            NO

Replace  
control board.

Check belt  
and pulley.

Is the display showing Encoder count with  
a "1" at the end of the X Axis code?  
  

##### 1	##### 1
X axis	Y axis

  
 YES            NO

Check, repair, replace  
harness. Problem solved?  
YES            NO

"1" showing = a switch or  
ground wire issue.

"0" showing = a  
mechanical  
obstruction.  
NO            YES

Check & replace motor.  
Problem solved?  
YES            NO

Replace  
control board.



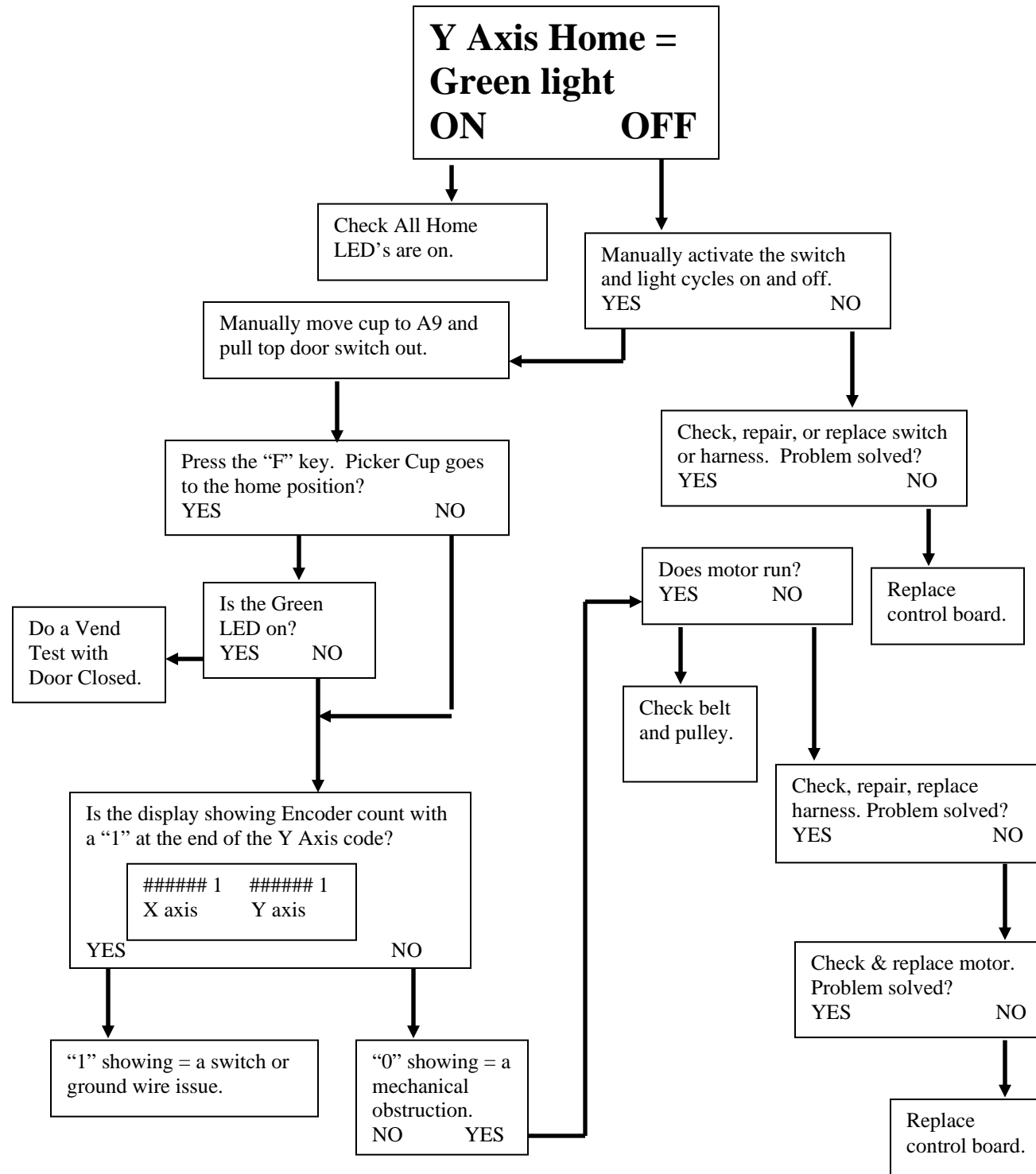

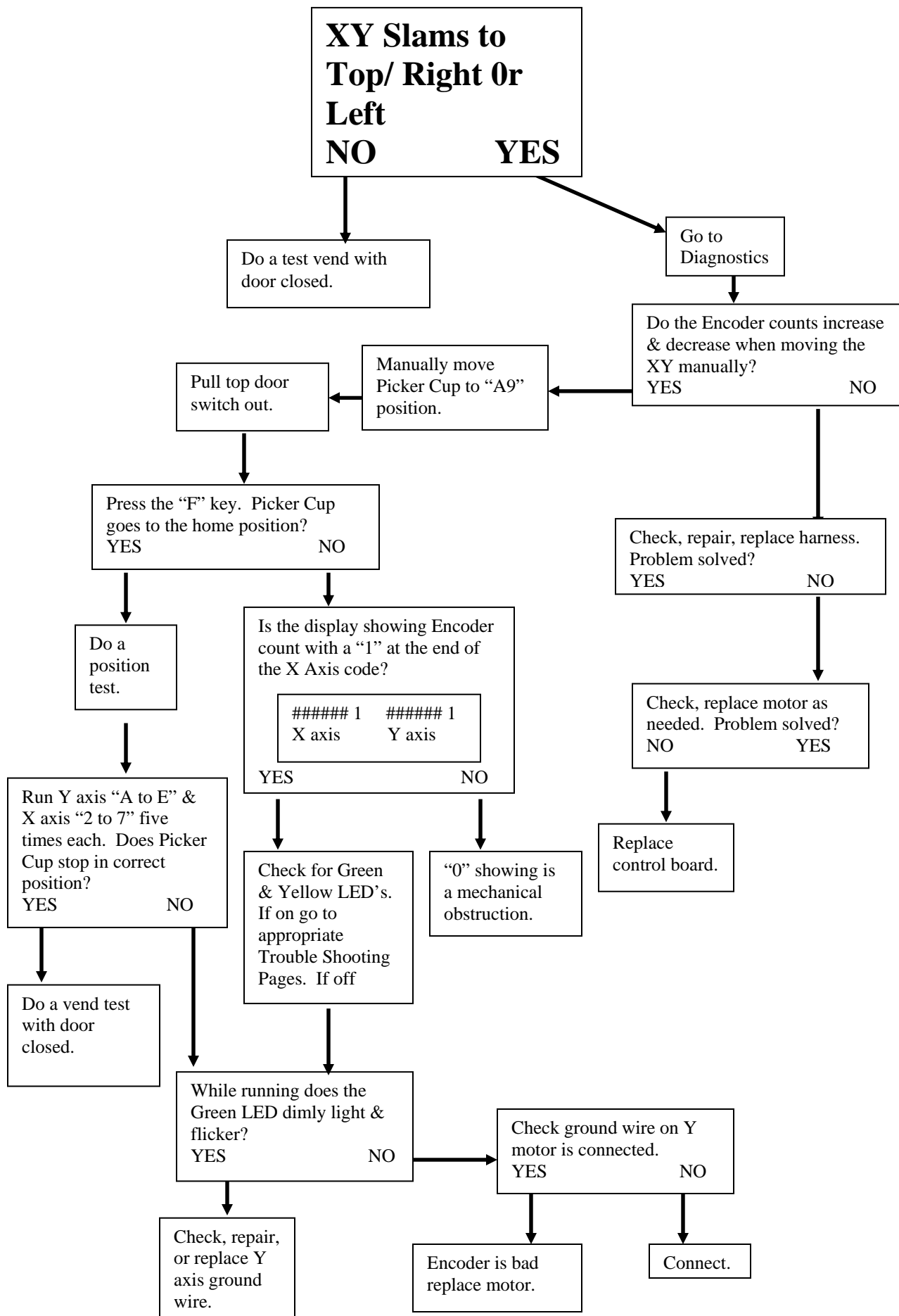

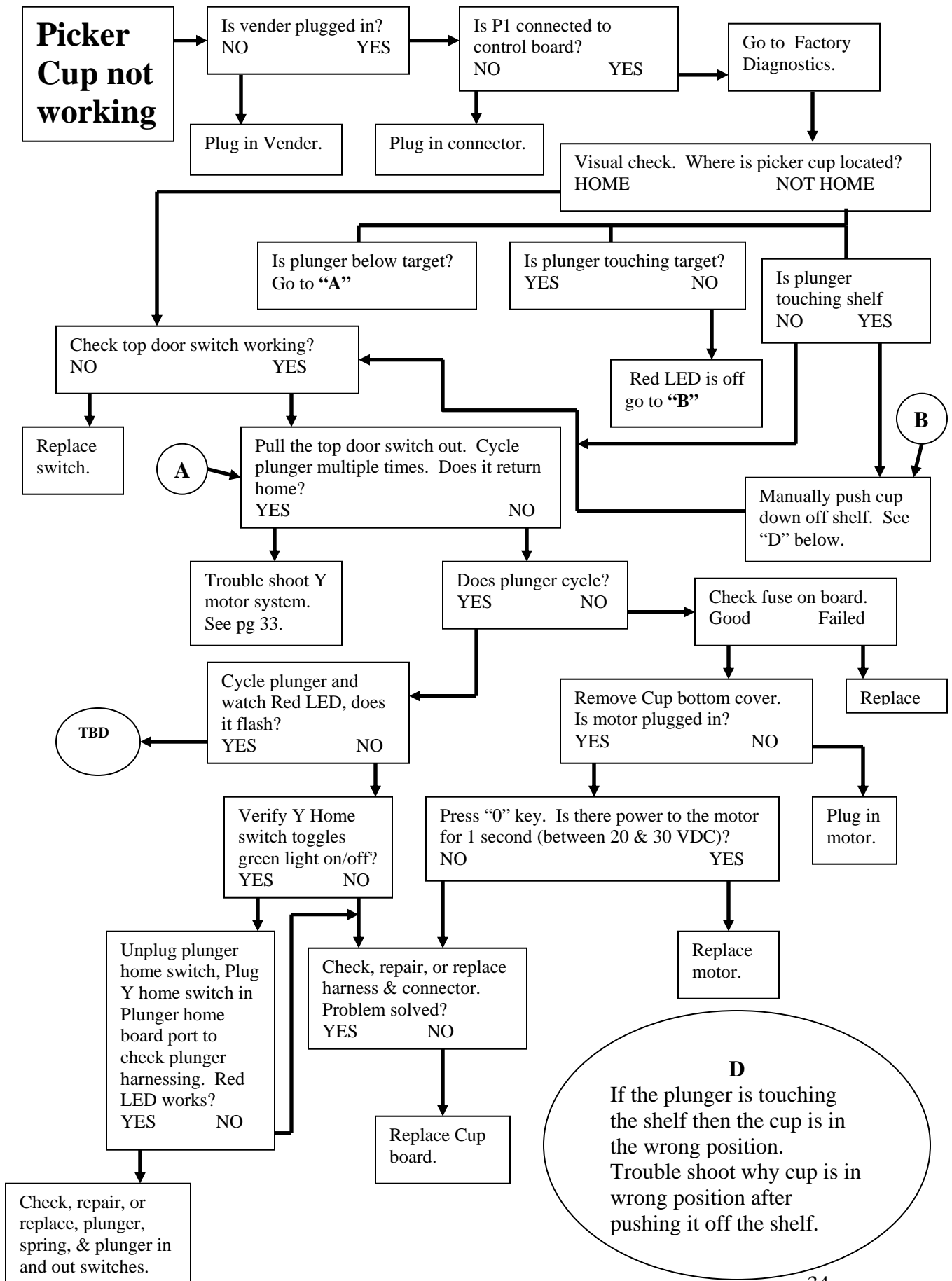

# CUP AT WRONG LOCATION HIGH/LOW or Y AXIS

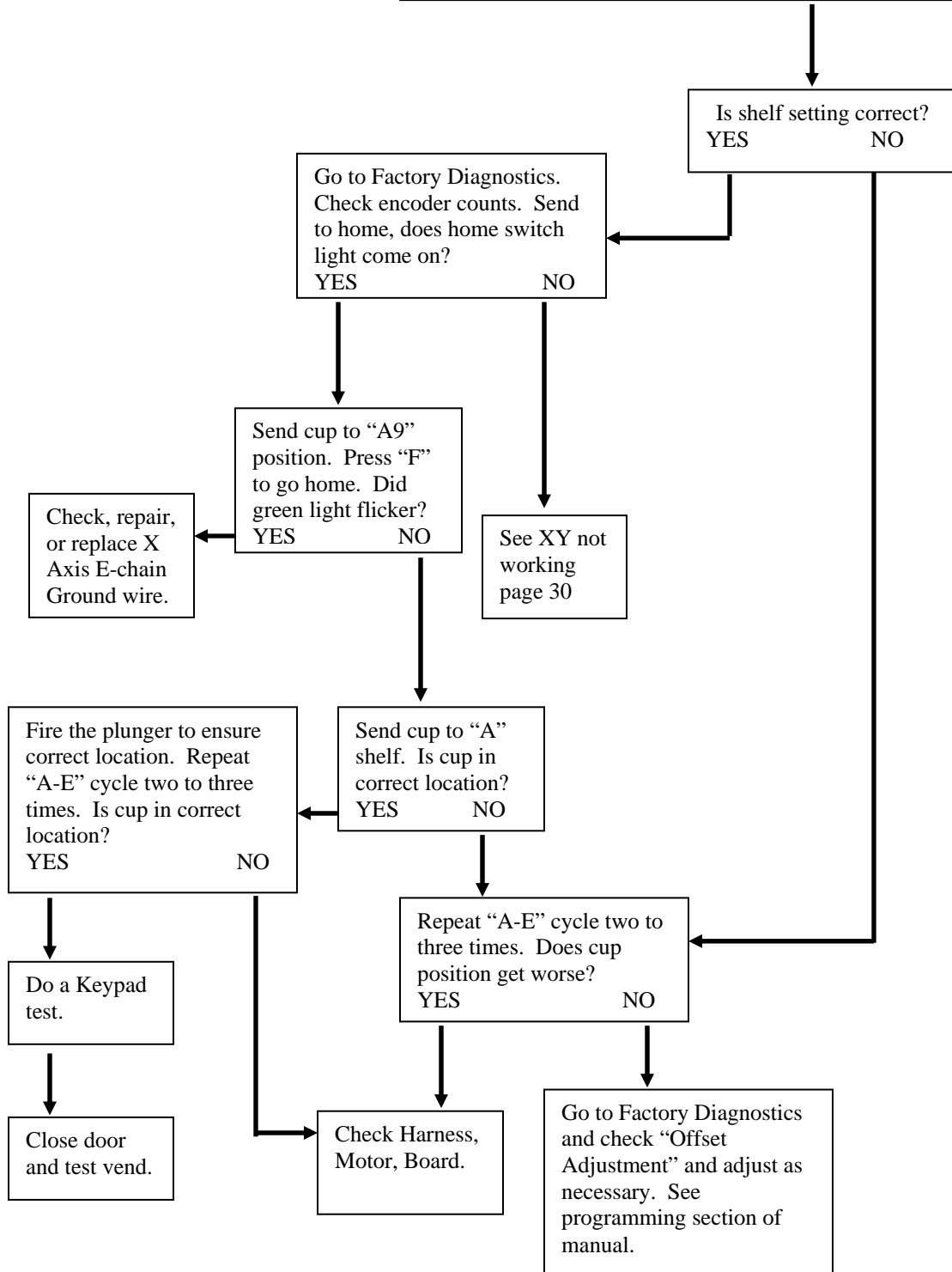

# CUP AT WRONG LOCATION LEFT /RIGHT or X AXIS

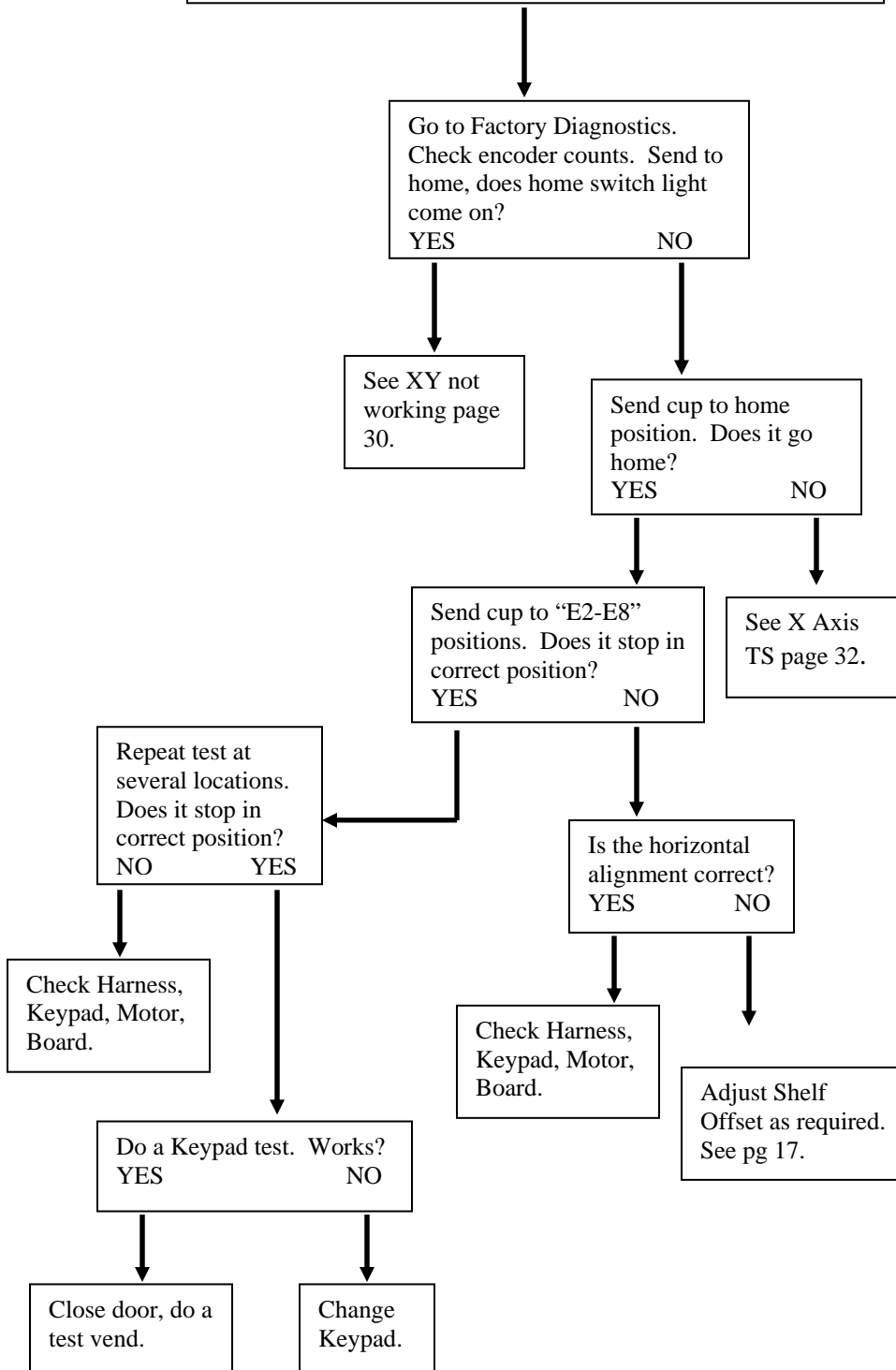

# DELIVERY PORT DOOR WORKS IN FACTORY DIAGNOSTICS BUT NOT IN SALES MODE

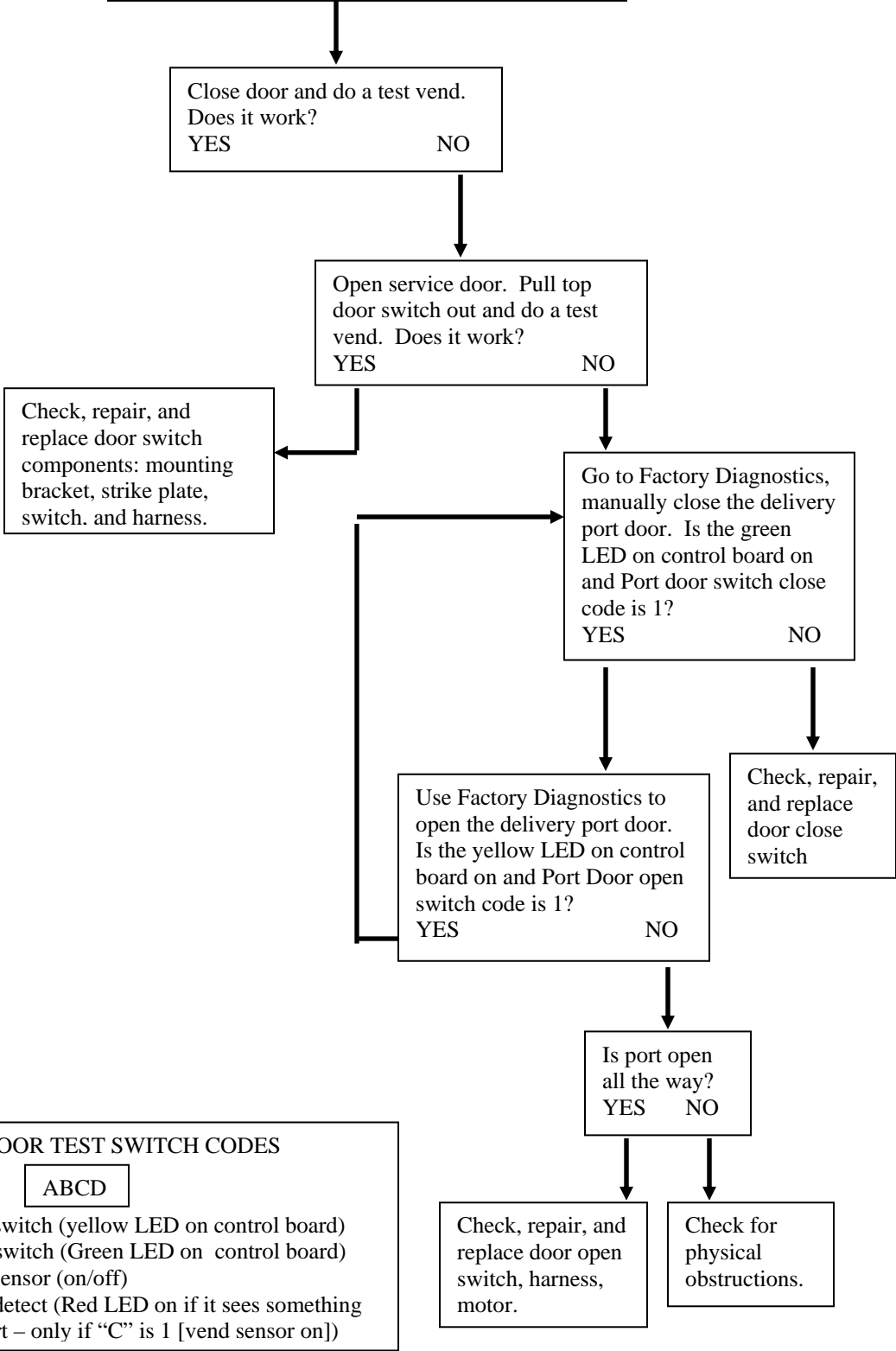

PORT DOOR TEST SWITCH CODES	
ABCD	
Position A = Open switch (yellow LED on control board)	
Position B = Close switch (Green LED on control board)	
Position C = Vend sensor (on/off)	
Position D = Vend detect (Red LED on if it sees something in port – only if “C” is 1 [vend sensor on])	

### COIN ACCEPTANCE ISSUES

PROBLEM	CAUSE	FIX
Coins Returned to Customer With No Credit Issued	<ol style="list-style-type: none"> <li>1. Coin Jam in Mech</li> <li>2. Flight Deck Dirty</li> <li>3. No Power to Mech</li> <li>4. Coin Return Lever Activated</li> <li>5. Vender in Test Mode</li> <li>6. Not Available Time Set</li> <li>7. Defective Coin Mech</li> </ol>	<ol style="list-style-type: none"> <li>1. Clear Jam and Test</li> <li>2. Clean Flight Deck</li> <li>3. Check Harness, Changer to VCU</li> <li>4. Adjust Coin Return Lever</li> <li>5. Close Service Door</li> <li>6. Disable Not Available Time</li> <li>7. Replace Mech</li> </ol>
Will Not Payback Coins	<ol style="list-style-type: none"> <li>1. No Power to Mech</li> <li>2. No Coins in Tubes</li> <li>3. Tubes Programmed Incorrectly (4 Tube Mech)</li> <li>4. Defective Coin Mech</li> </ol>	<ol style="list-style-type: none"> <li>1. Check / Replace MDB Harness</li> <li>2. Fill Coin Tubes with Coins</li> <li>3. Reprogram per Manufacturer Recommendation</li> <li>4. Replace Coin Mech</li> </ol>

### DOLLAR BILL ACCEPTANCE ISSUES

PROBLEM	CAUSE	FIX
Bill Validator will not run.	Prices / tube cash conditions.	Check Mech Tubes.
Takes Bill in Then Rejects it		Check Validator or Replace
Stacks Bill While in Escrow Mode	Max Price Not Yet Reached	
Bill Error Listed in Test Mode	Communication Error with Bill Validator. Bill Validator Reported Error.	
Takes Bill, Gives No Credit	Board, Harness, Validator	Check or Replace Validator Harness, Replace Board

### CONTROL BOARD (VCU)

PROBLEM	CAUSE	FIX
No Power to Controller.	1. AC Box	1. Replace AC box.
??????? Showing on Display	<ol style="list-style-type: none"> <li>1. Incorrect Input to Controller</li> <li>2. Low or Missing 24 Volts</li> </ol>	
Out of Order or other error codes showing on display	RAM Error	Refer to Programming Section on page ## for specific error codes and cures.
Temp out of Service	No Vendable Selections	

These charts are intended as a guide to isolate and correct most problems you might encounter. Should your machine show 'OUT OF SERVICE', go in the TEST MODE and press "B" to list errors.

### ALL COINS ARE REJECTED

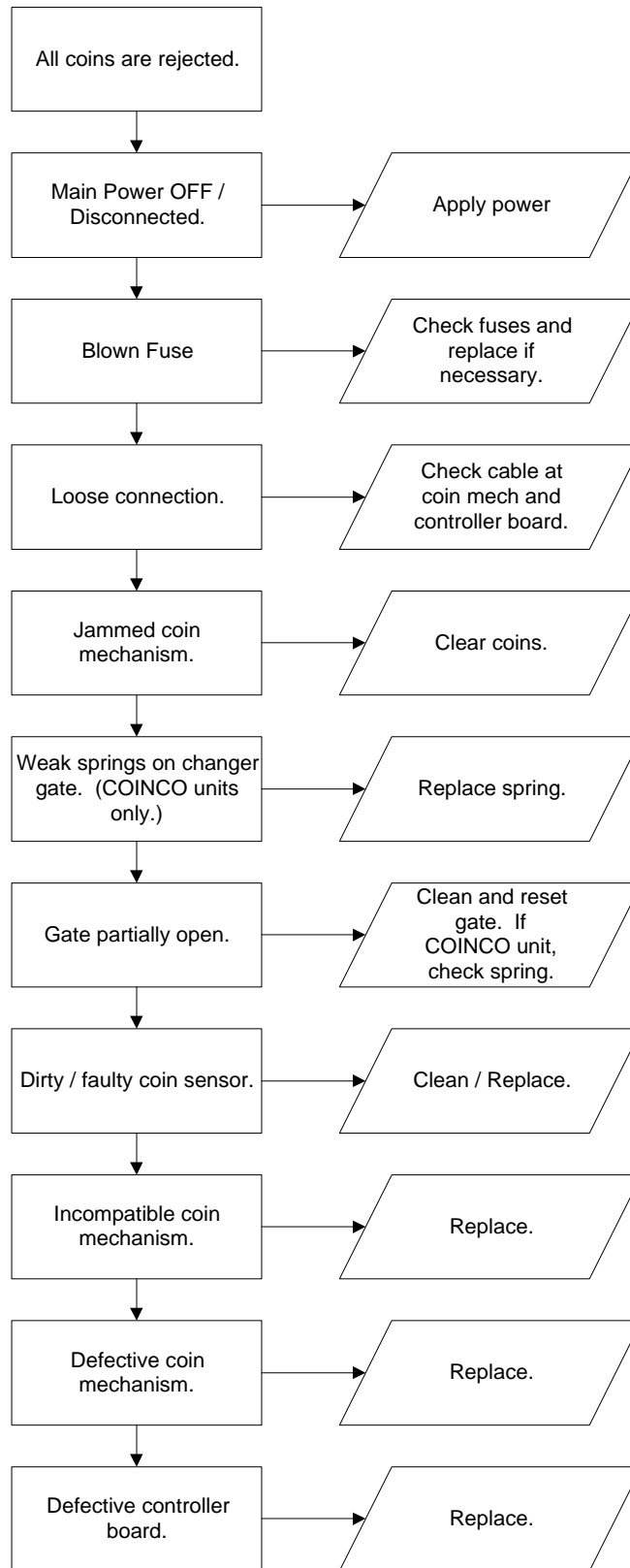



## ALL BILLS ARE REJECTED

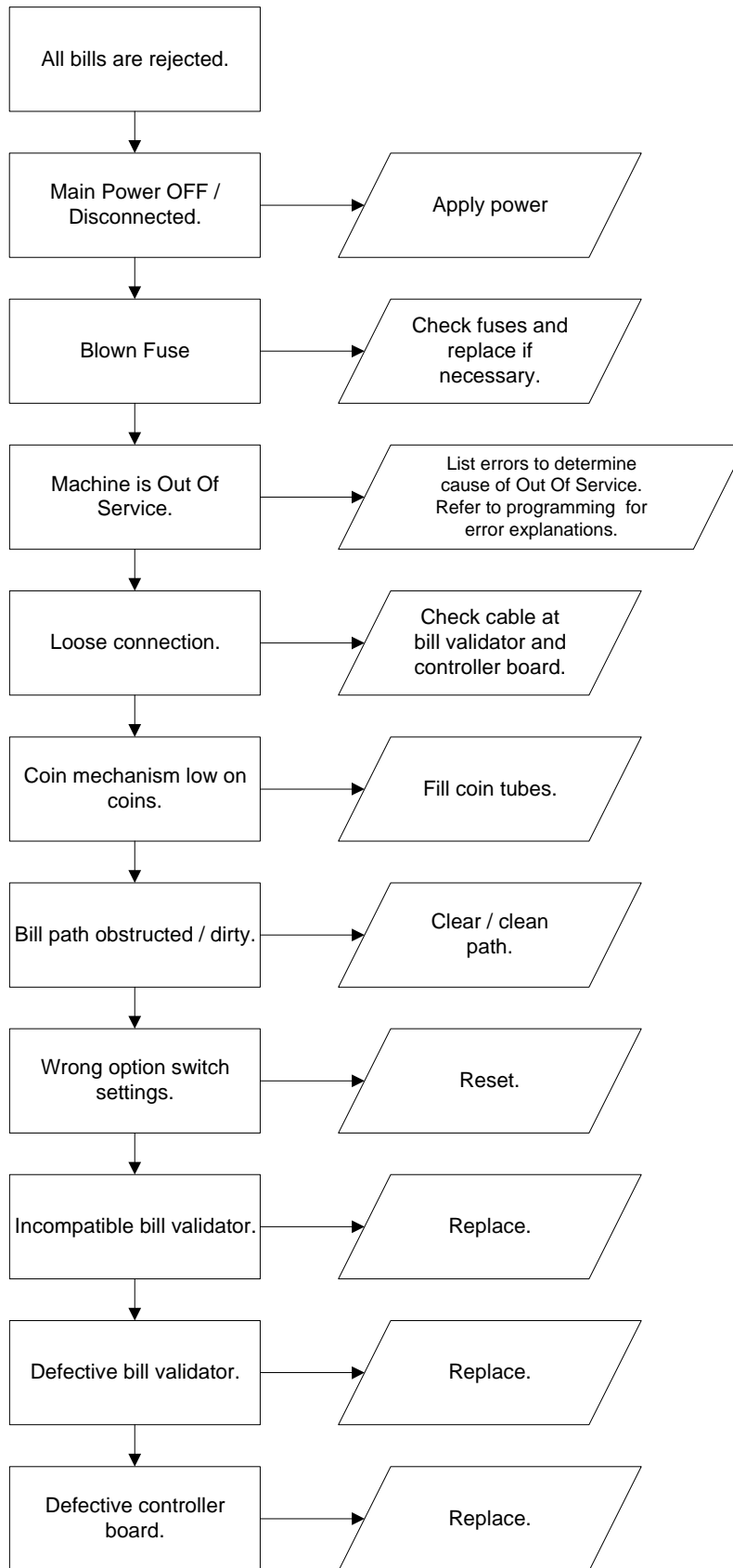

## INCORRECT CHANGE DISPENSED

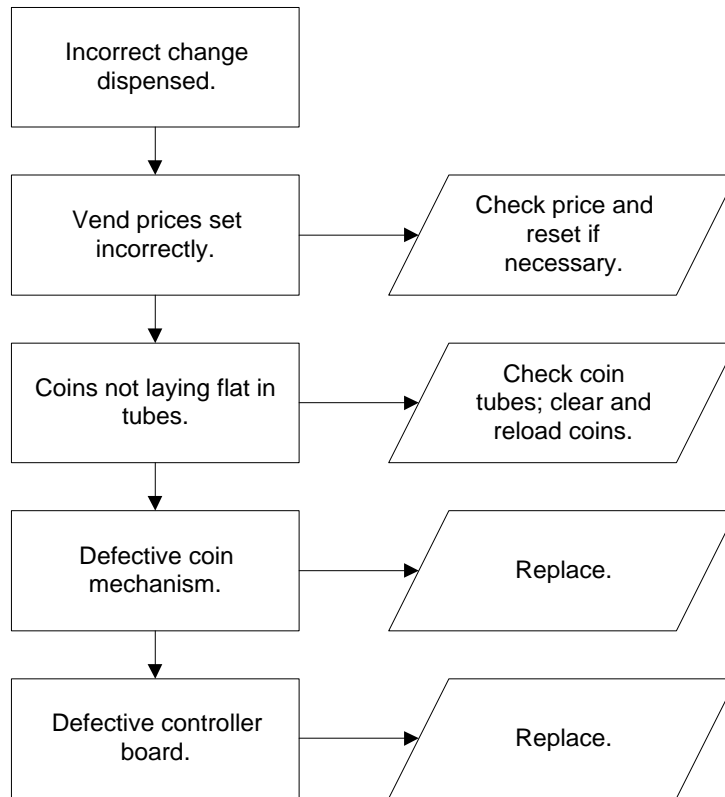

## SELECTION WILL NOT VEND

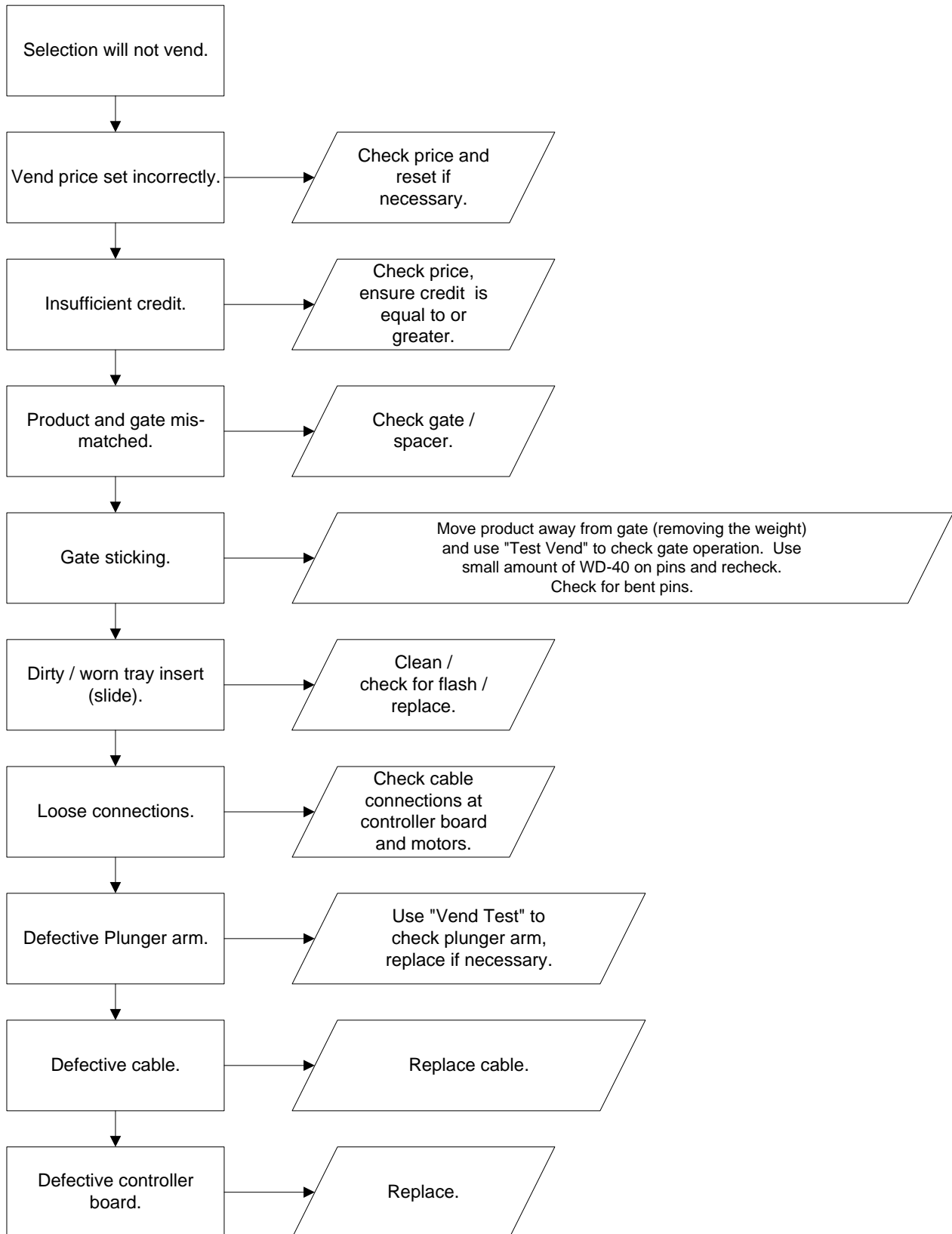

### ICE / FROST ON EVAPORATOR

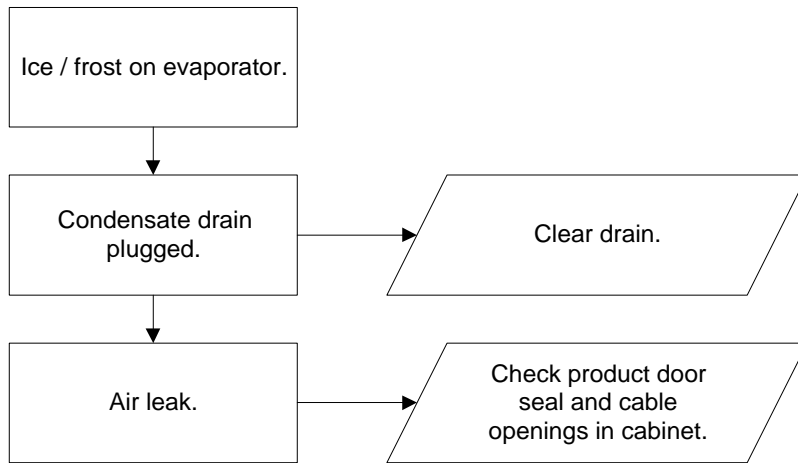

### CONDENSATE ON OUTSIDE OF PRODUCT DOOR

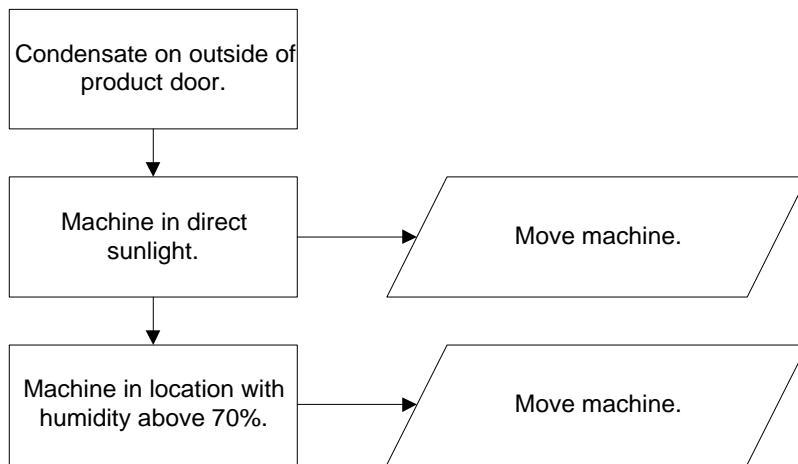

### COMPRESSOR WILL NOT STOP

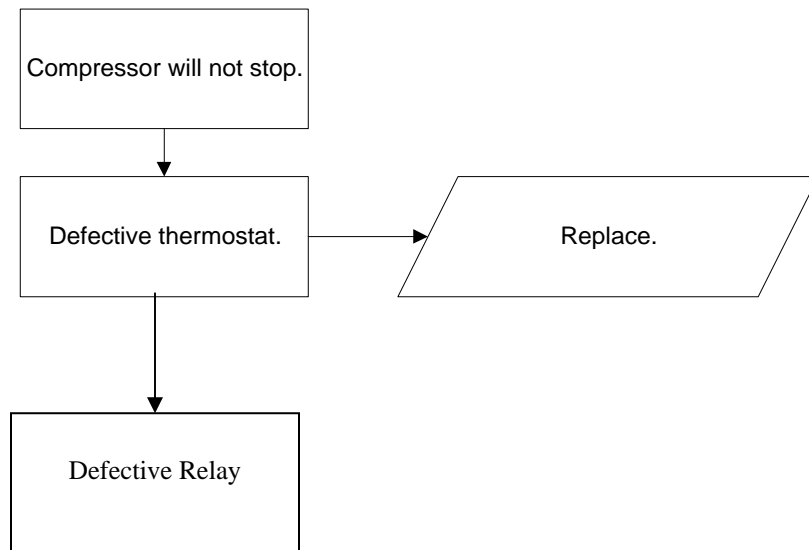

## COMPRESSOR WILL NOT START

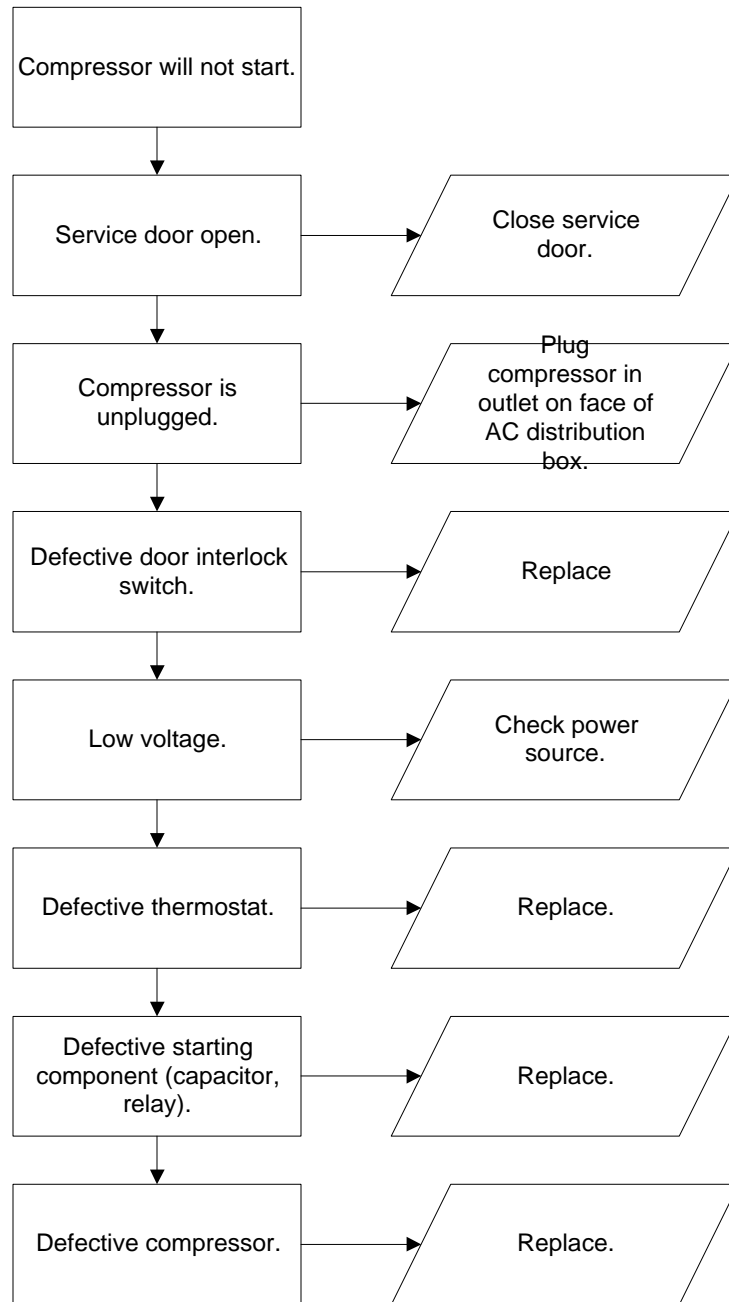

**Troubleshooting Tip:** Use a short 15 Amp extension cord and plug the compressor directly into the wall outlet. This will bypass the AC distribution box.  
**Note:** For Testing Purposes Only.

## MACHINE NOT COOLING

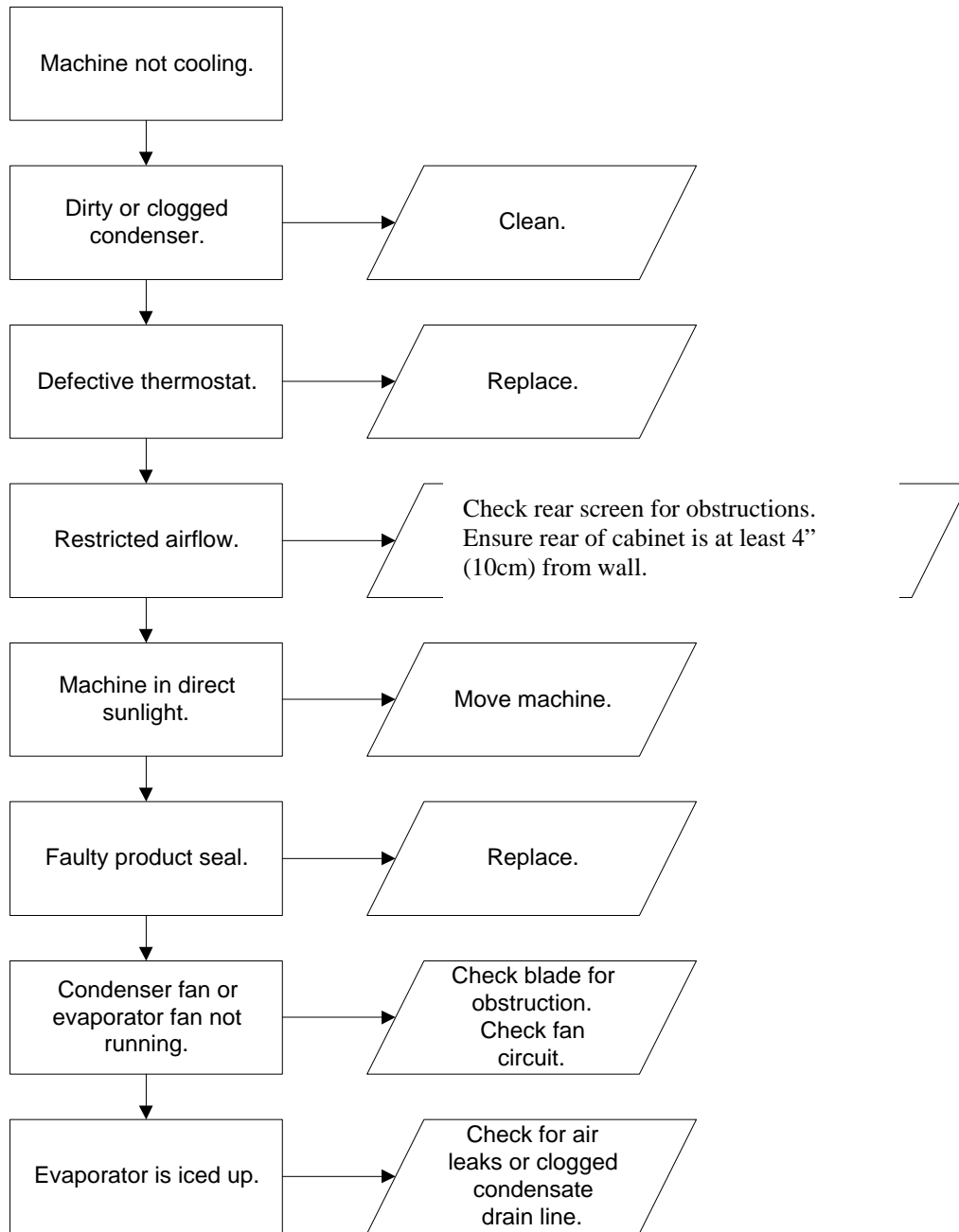

### Bev Max 2 Domestic Block Diagram

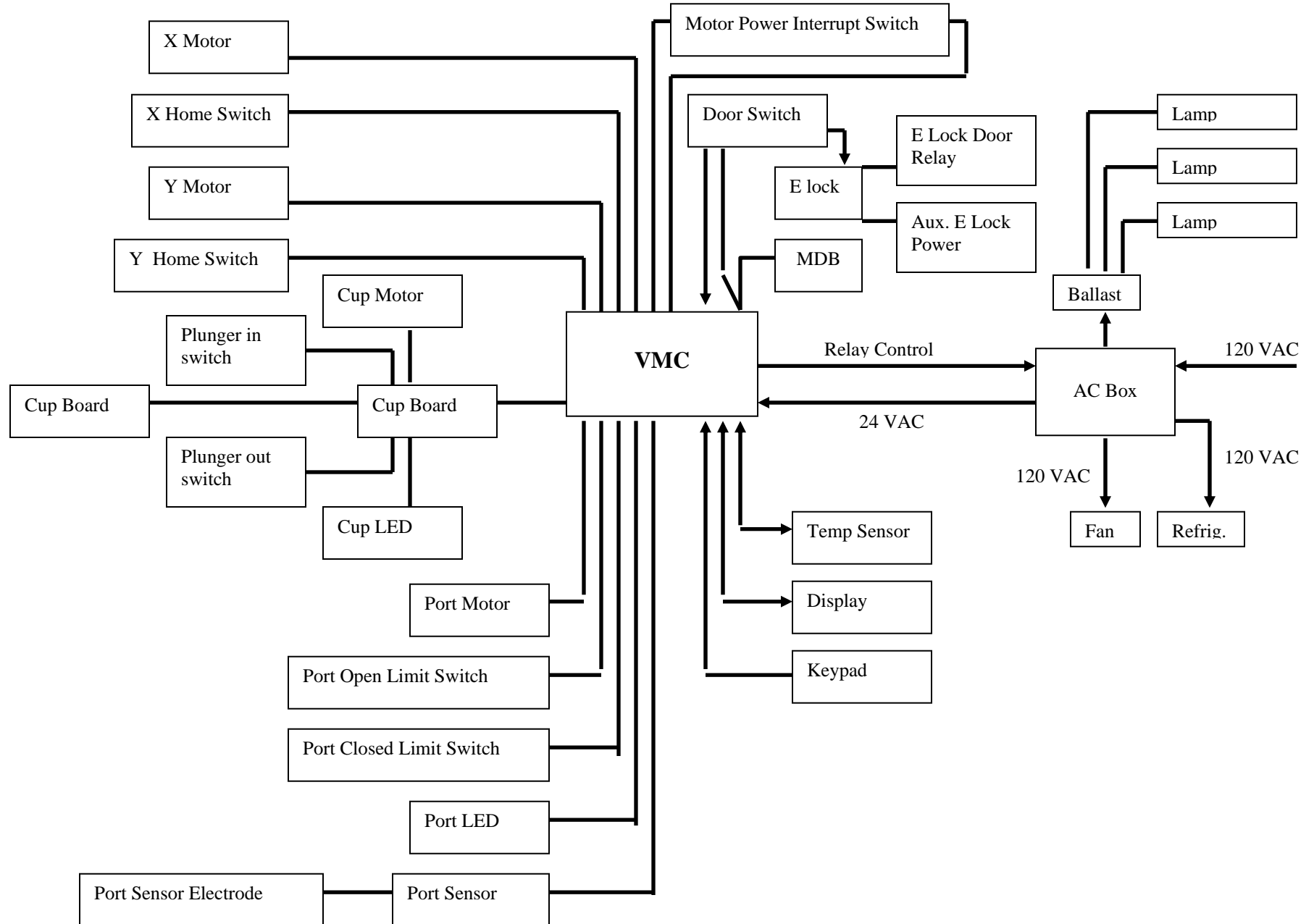

### Bev Max 2 Export Block Diagram

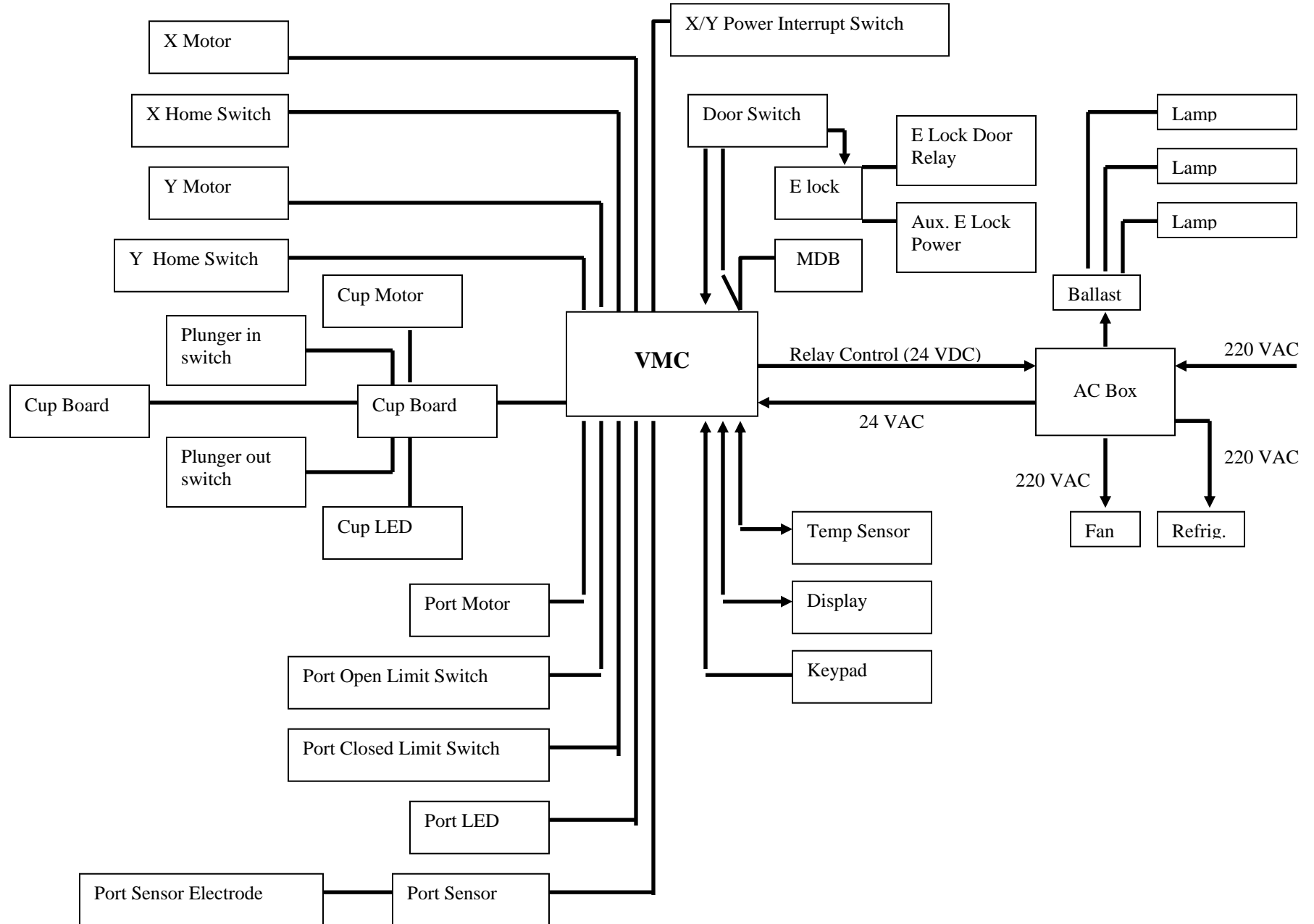





# Bev Max 2 Cabinet Diagram (Domestic & Export)

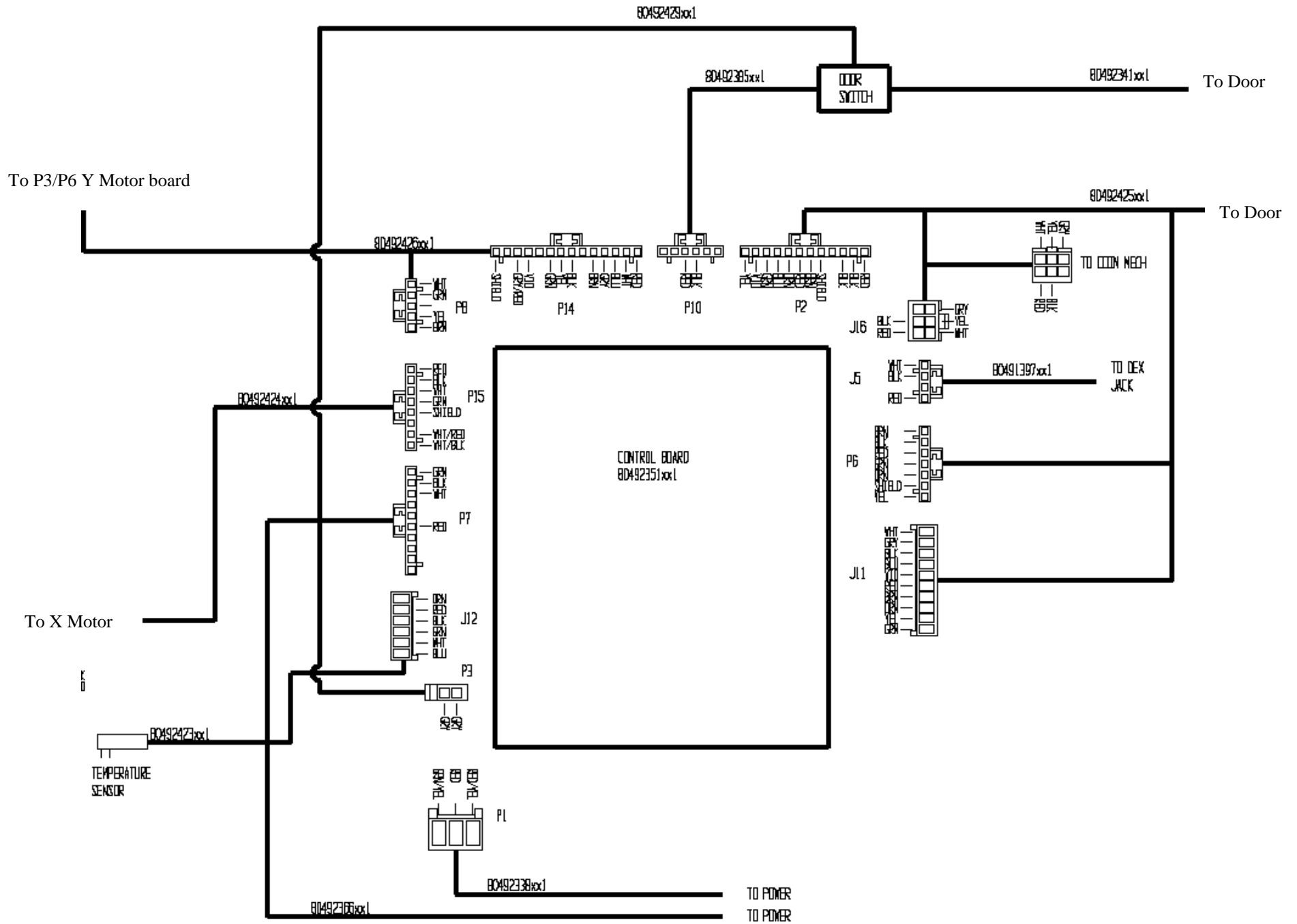

### Bev Max 2 Door Diagram (Domestic & Export)

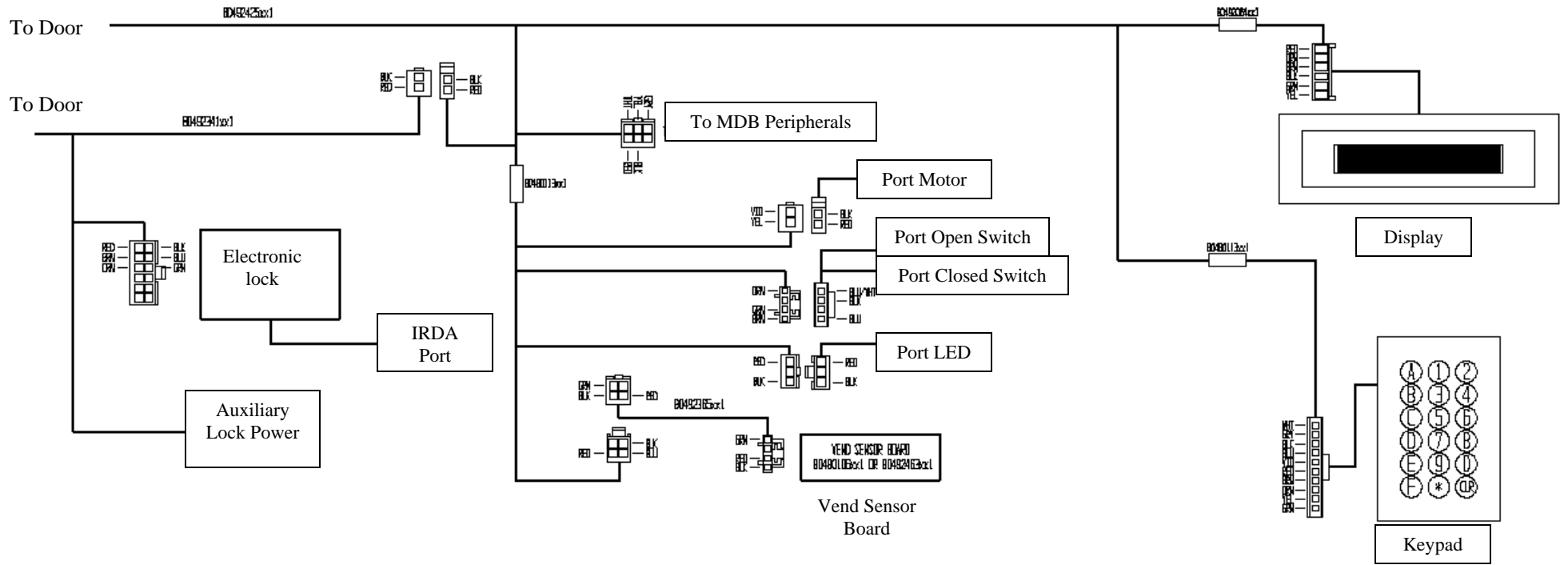



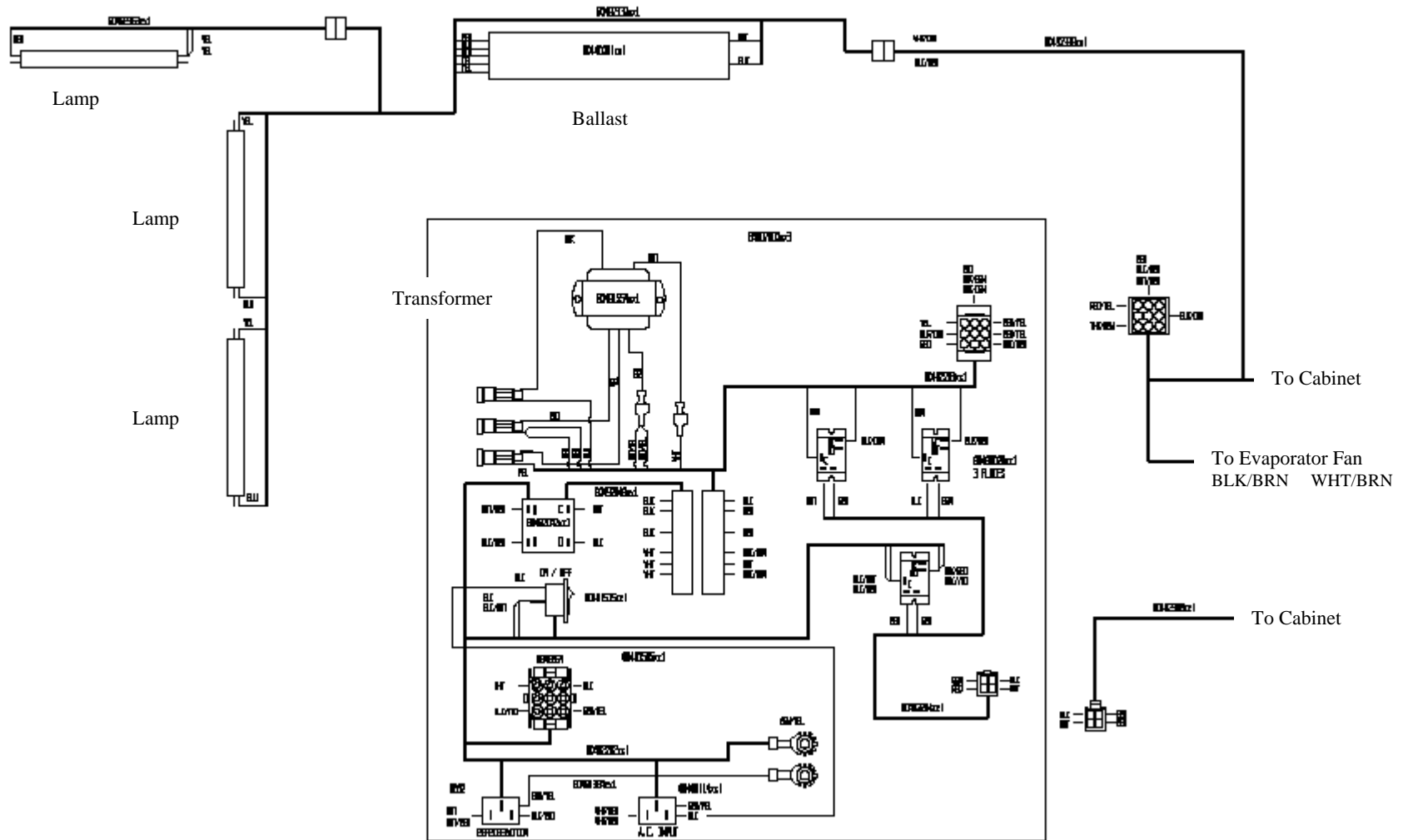



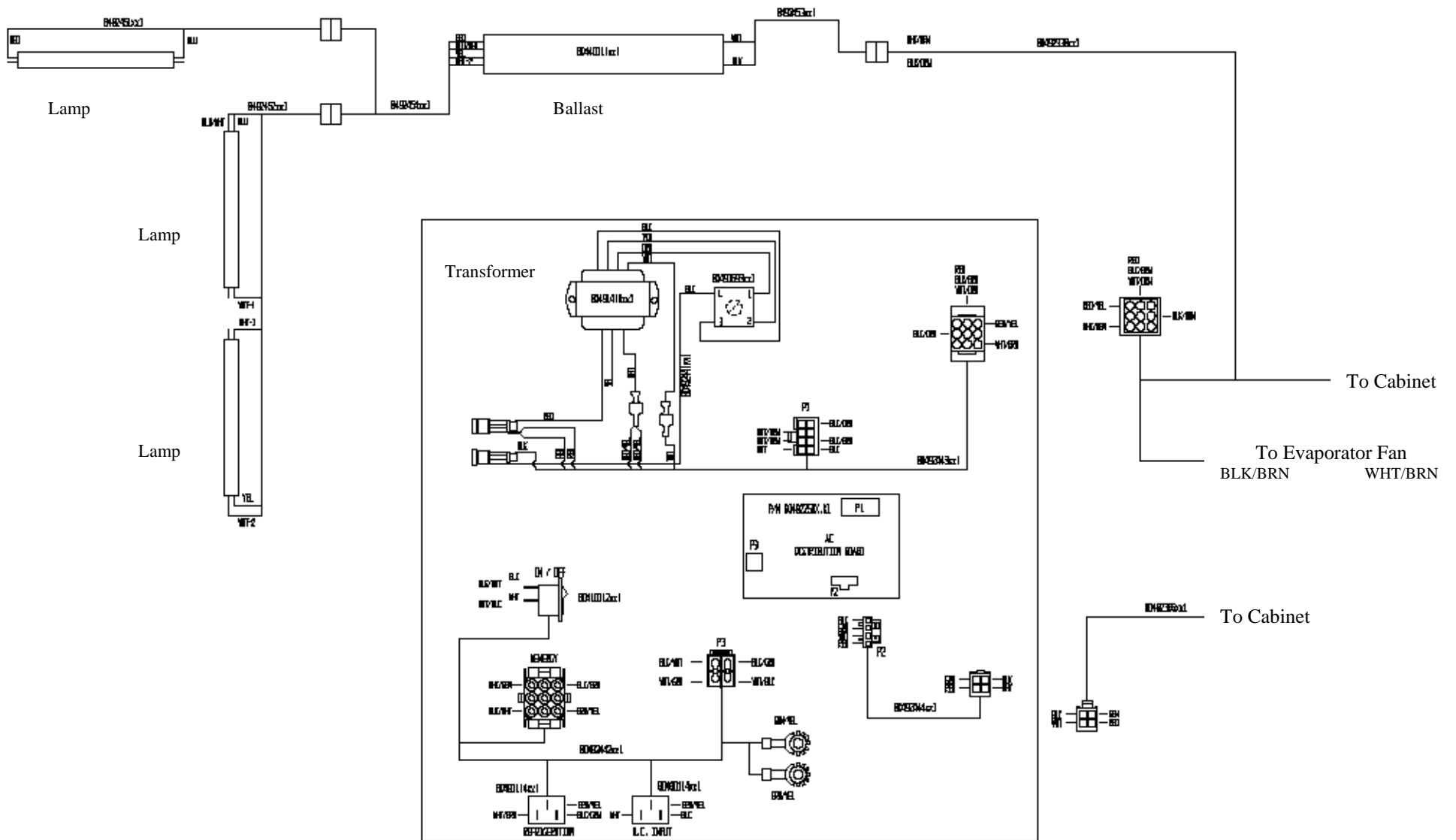

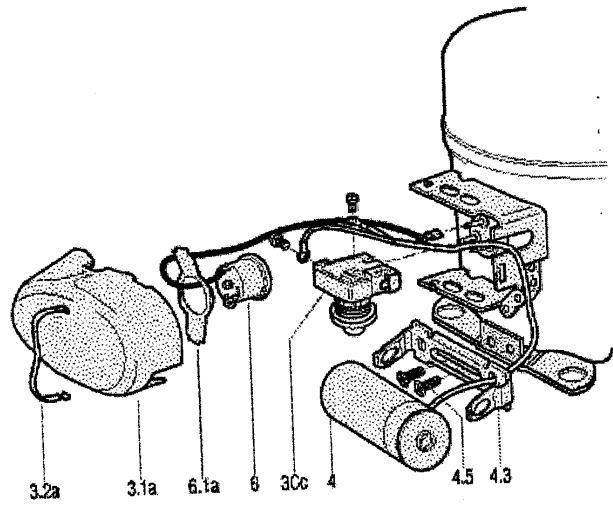

## Bev Max 2 Domestic Power & Lighting Diagram



# Bev Max 2 Export Power & Lighting Diagram





Ref	Symbol	Description
3Cc		Current Start Relay with Capacitor Connections
3.1a		Cover
3.2a		Cover Spring
4		Start Capacitor
4.3		Capacitor Clamp
4.4		Capacitor fixing bracket
4.5		M5 Self-tapping Screw
6		Overload Protector
6.1a		Overload Spring

**Bev Max 2 Compressor Parts Diagram**

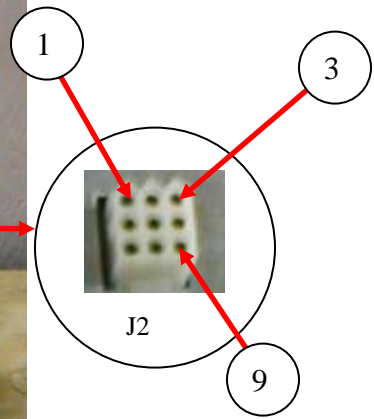
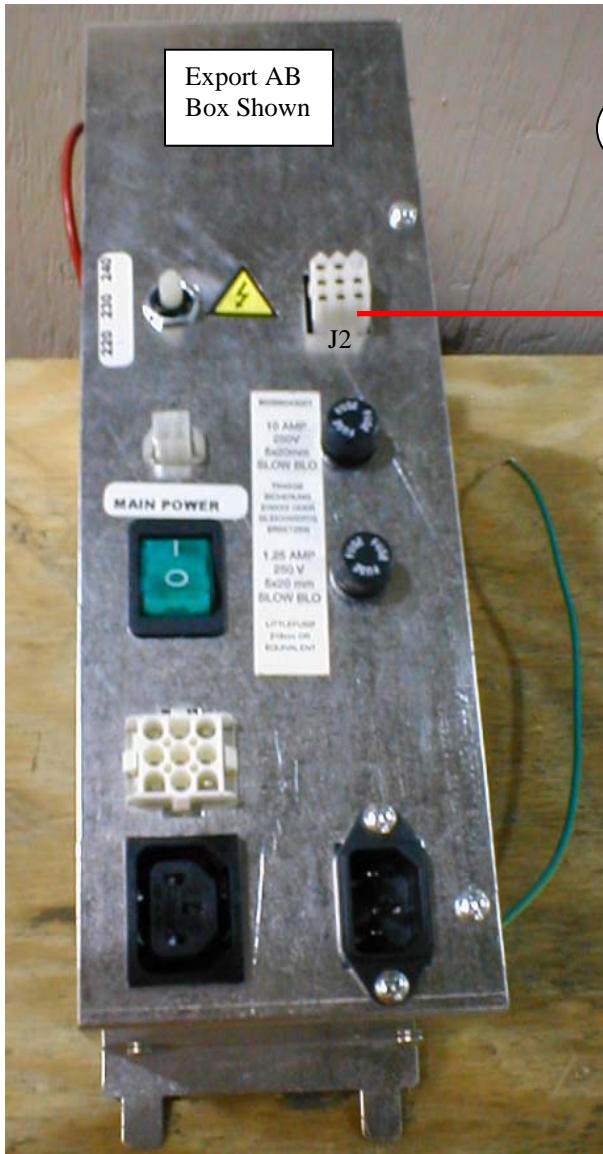

AC TEST VOLTAGES			
Between Pins		Domestic Reading	Export Reading
1	2	24 VAC	24 VAC
1	3	12 VAC	12 VAC
2	3	12 VAC	12 VAC
4	9	24 VAC	24 VAC
5	7	115 VAC	220 VAC
6	8	115 VAC	220 VAC

AC DISTRIBUTION BOX, J2 VOLTAGES

# PARTS LIST

PARTS LIST AND DIAGRAMS.....	56 – 84
Machine Front View .....	57 – 58
Cabinet Detail Product Area.....	59 – 60
Cabinet Detail Service Door Area .....	61 – 62
XY Motor Picker Unit.....	63 - 64
Service Door Outside.....	65 – 66
Service Door Inside.....	67 – 68
Gate Tray Detail .....	69 – 70
AC Distribution Box .....	71 - 72
Lighting.....	73
Refrigeration Unit Fin & Tube Condenser.....	74 – 76
Electronics.....	77
Harnesses .....	78 – 79
Labels / Decals / Misc. ....	80
Screws & Nuts.....	81 – 82
Washers, Bolts, & Misc. Hardware .....	83 – 85



# MACHINE FRONT VIEW

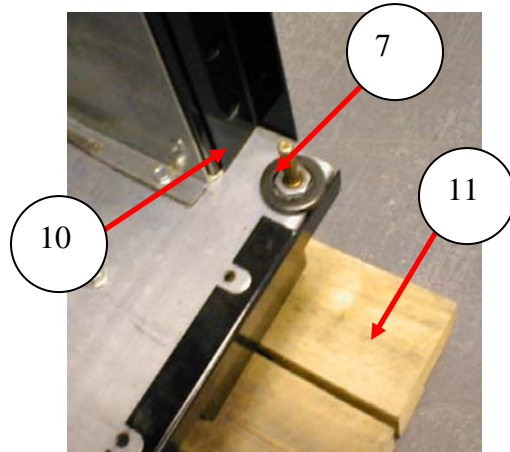
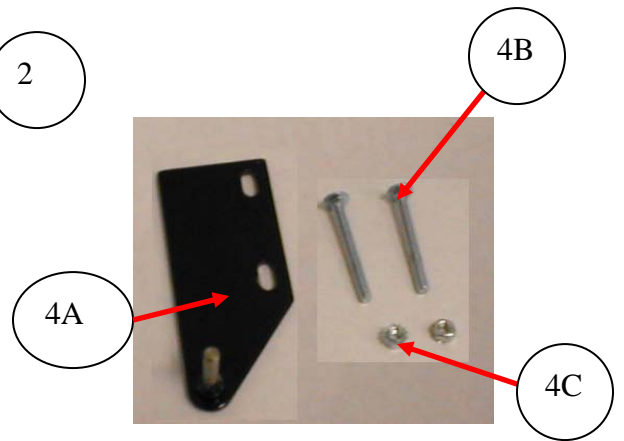
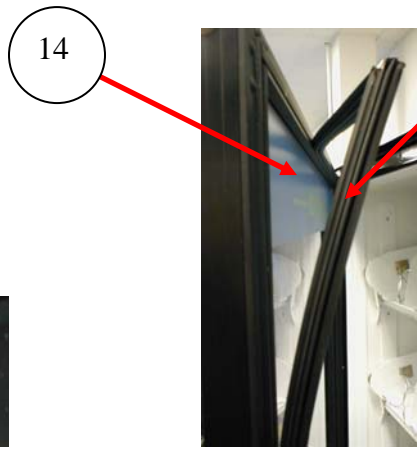
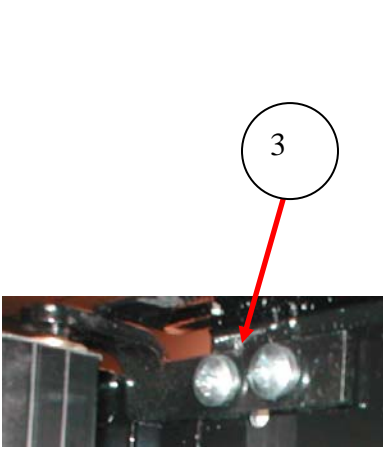
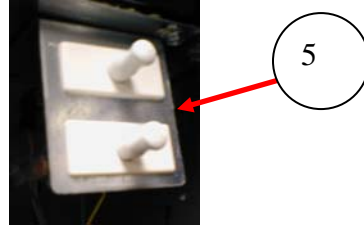
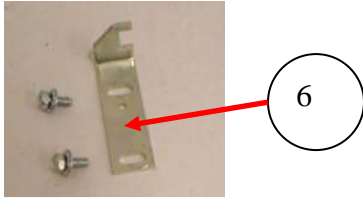



# CABINET DETAIL PRODUCT AREA

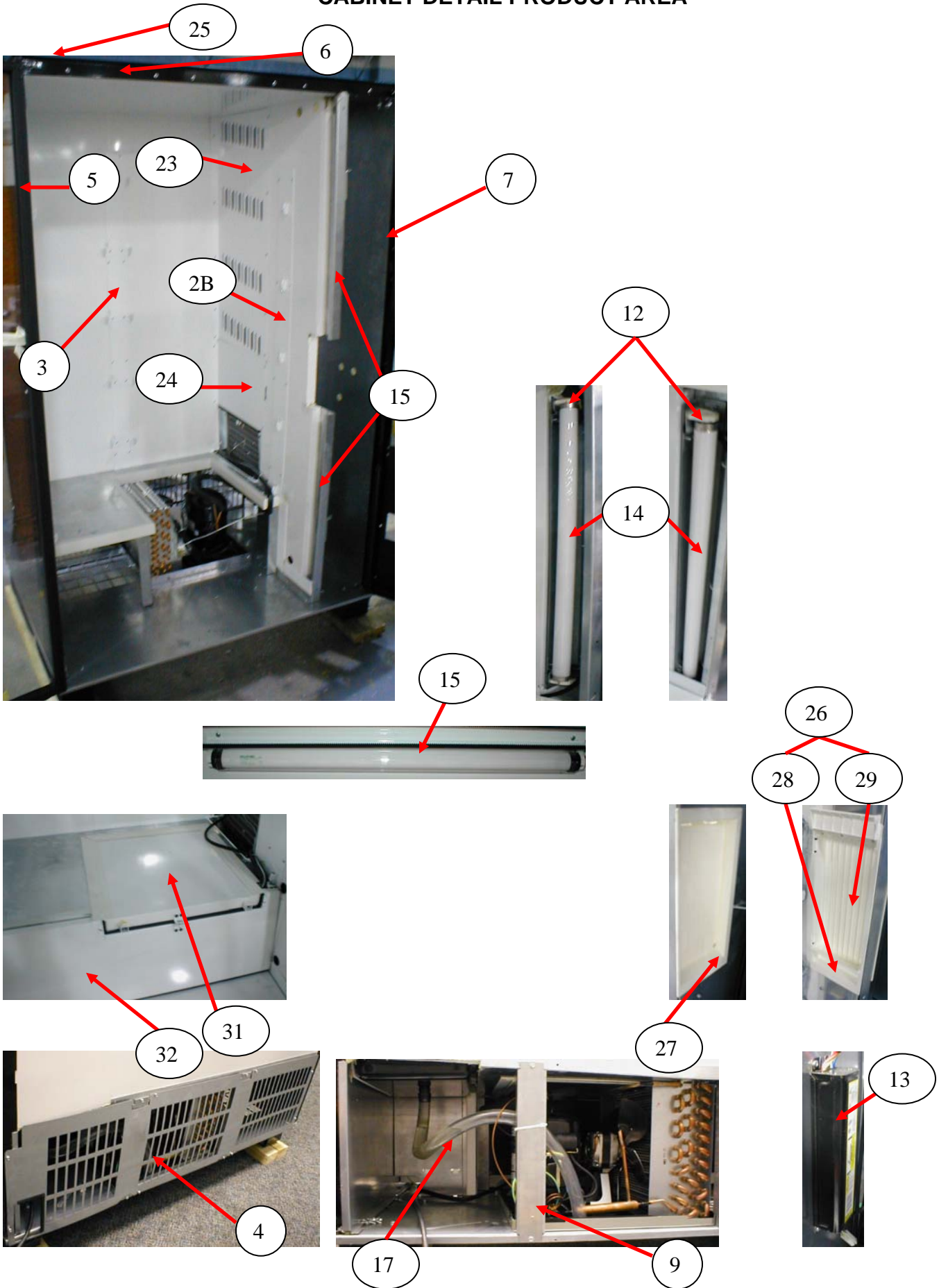

## CABINET DETAIL PRODUCT AREA

ITEM	PART DESCRIPTION	DN5800
1	Cabinet Assembly	647,060,00x.x3
2A	Left Tray, Bev-Max 2 Mount Bracket	647,070,05x.x3
	Left Tray, Bev-Max 2 Rail	647,070,08x.x3
2B	Right Tray, Bev-Max 2 Mount Bracket	647,070,04x.x3
	Right Tray, Bev-Max 2 Rail	647,070,07x.x3
3	Rear Tray Support Bar, Bev-Max 2	647,070,06x.x3
	Rear Tray Mount Bracket	647,070,03x.x3
4	Ingress Guard (Service Item)	647,000,02x.x3
5	Security Angle, Left	647,060,07x.x3
6	Security Angle, Top	647,060,06x.x3
7	Security Angle, Right	622,020,12x.x3
8	Service Door Security Angle (refer to Service Door Page)	647,050,04x.x3
9	Brace, Rear Base Plate	635,020,09x.x3
10	Tray Support Screw #8-18x1/2 Phil Pan	900,301,50x.x1
11		
12A	Lamp Holder, T8 Bi-Pin Leviton 23652 (Vertical)	804,920,62x.x1
12B	Lamp Holder, T8 Bi-Pin Leviton 23653 (Horizontal)	TBD
13	Assembly, Ballast 120V/60Hz Electronic (Advance) T8	804,400,61x.x1
14	Lamp, Fluorescent T8 2' OS#21718	804,700,77x.x1
15	Lamp Cover, Top Horizontal	801,819,89x.x1
16	Evaporator Drain Pan Assembly	622,041,20x.x3
	Evaporator Drain Pan	801,813,48x.x1
17	Drain Tube	801,817,41x.x1
18	Evaporator Fan Assembly (120V/60Hz, 9W)	627,052,40x.x3
19	Evaporator Fan, 58mm ECM	804,501,28x.x1
20	Evaporator Fan Harness	804,922,37x.x1
21	Evaporator Fan Shroud	627,050,45x.x3
22A	Choke	804,920,41x.x1
22B	Harness, Fan Choke Extension	804,922,77x.x1
23	Louver Panel	647,070,09x.x3
24	Evaporator Bottom Access Panel	627,051,30x.x3
25	Weld Assembly Glass Front Top Hinge	801,306,49x.x1
26	Assembly Discharge Frame	801,819,94x.x1
27	Discharge Back Frame	801,819,95x.x1
28	Discharge Frame	801,819,96x.x1
29	Discharge Door	801,819,97x.x1
30	Discharge Door Magnet	804,101,05x.x1
31	Shelf Panel Assembly	647,060,40x.x3
32	Foamed Vertical Panel Assembly	647,060,10x.x3
	Part numbers & descriptions are subject to change with out notice. NA = Not applicable TBD = To be determined	

### CABINET DETAIL SERVICE DOOR AREA

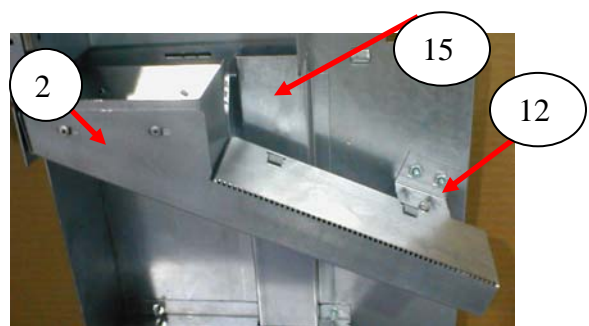
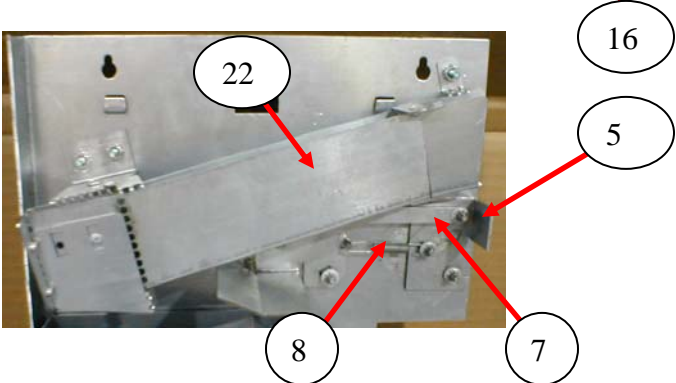
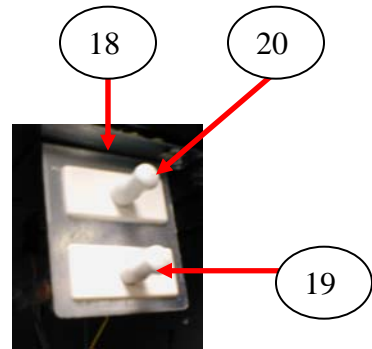
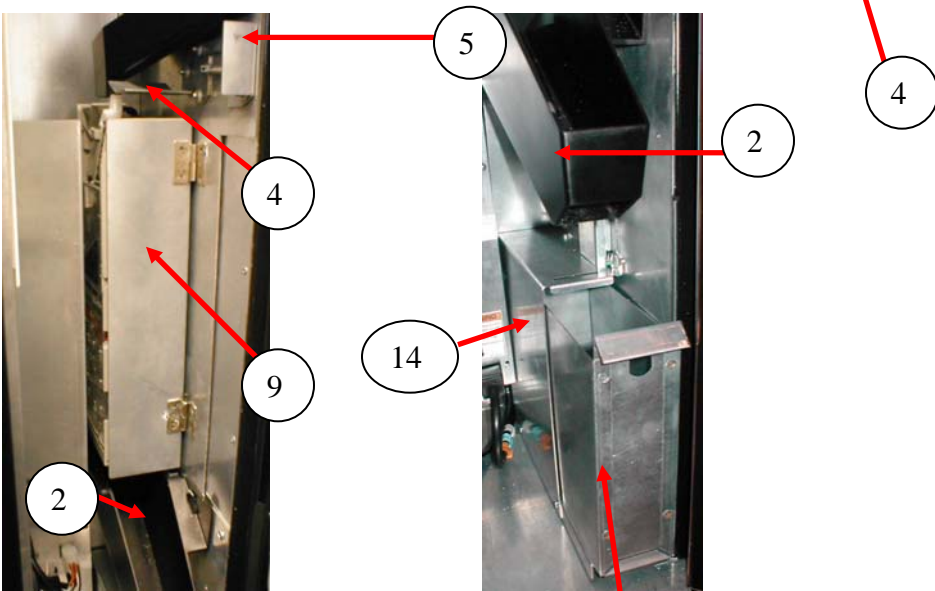
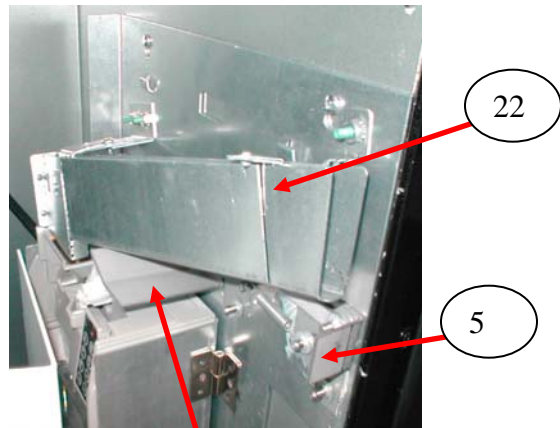
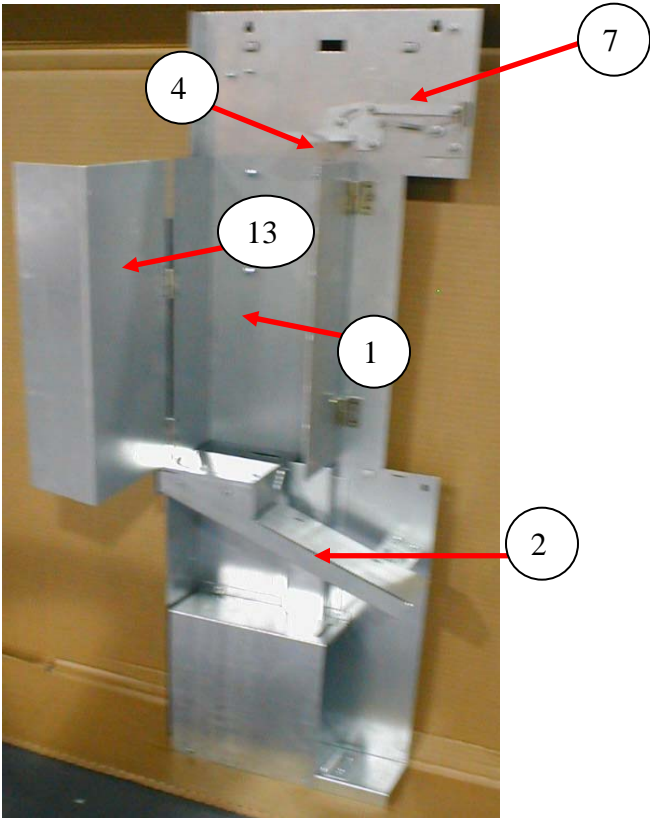



# XY MOTOR PICKER UNIT

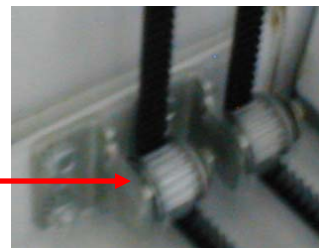
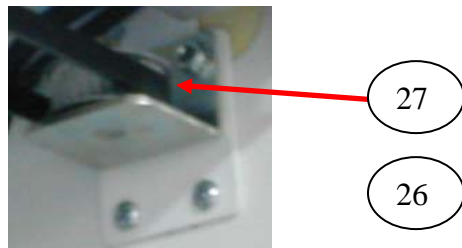
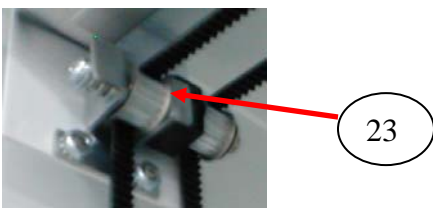
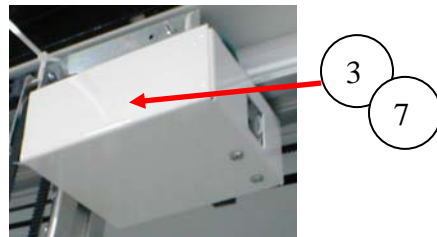
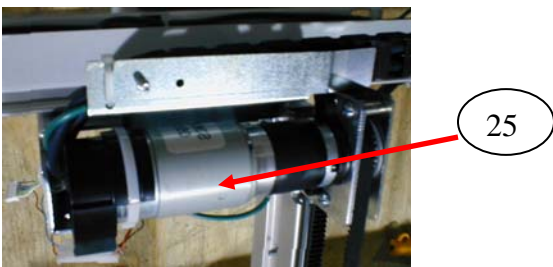
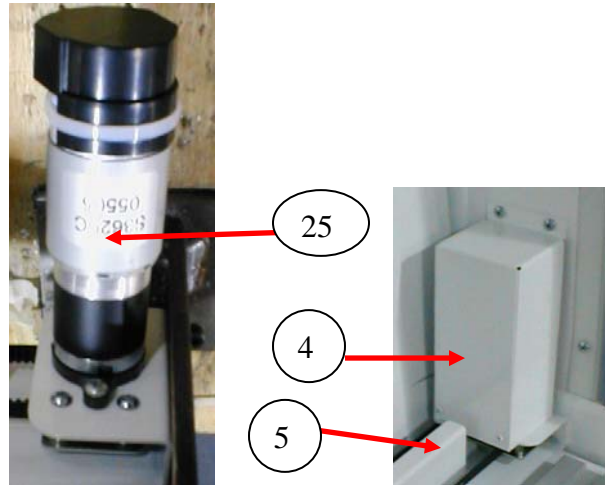
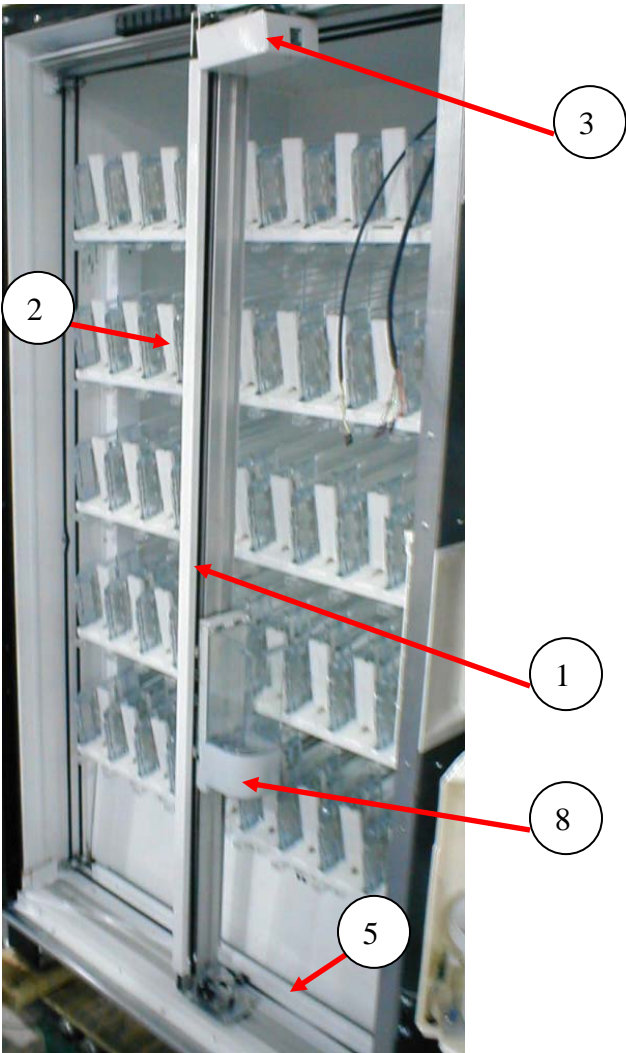

## X/Y MOTOR PICKER UNIT

ITEM	PART DESCRIPTION	DN5800
1	XY Delivery System	647,071,60x.x3
2	Assembly Cover Y Belt	647,070,28x.x3
3	Y Motor Cover Top	647,070,31x.x3
4	X Motor Cover Bottom	647,070,32x.x3
5	X Bottom Belt Guard Bracket	647,000,12x.x3
6	Harness, X Motor	804,924,24x.x1
7	X Top Carriage Assembly	647,073,50x.x3
8	Assembly Delivery Cup (Picker Cup Assy)	647,075,00x.x3
9	Delivery Cup Board (Picker Cup Board)	804,923,53x.x1
10	Cup Base Board	804,923,52x.x1
11	Cup/Port Motor Assembly	804,501,39x.x1
12	Cup Motor Cam	801,201,81x.x1
13	Micro Switch with Straight Arm (Picker Home Switch)	804,101,23x.x1
	Micro Switch with Straight Arm (Cup Home Switch – Y)	804,101,22x.x1
	Micro Switch with Bent Arm (Picker Out Switch)	804,101,26x.x1
14	Harness, XY Chain	804,924,26x.x1
15	Plunger Cup Bumper	803,601,23x.x1
16	Base Cup Cover	801,820,11x.x1
17	Base Cup	801,820,09x.x1
18	Delivery Cup Sleeve	801,820,08x.x1
19	Delivery Cup Body	801,820,07x.x1
20	Pin Cup Hinge	801,201,87x.x1
21	Assembly Plunger	647,051,80x.x3
22	Harness, Y E-Chain	804,923,73x.x1
23	XY Belt Tensioner Assembly	801,307,22x.x1
24	Motor Cam Cover	647,070,35x.x3
25	Motor XY System	804,501,41x.x1
26	Idler Pulley and Bracket Assembly	801,307,17x.x1
27	X Top Idler Pulley Assembly	801,307,45x.x1

Part numbers & descriptions are subject to change with out notice.  
 NA = Not applicable  
 TBD = To be determined



# SERVICE DOOR (OUTSIDE)

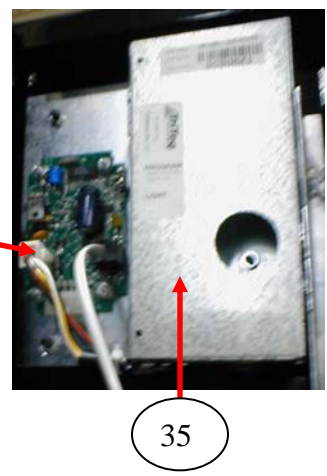
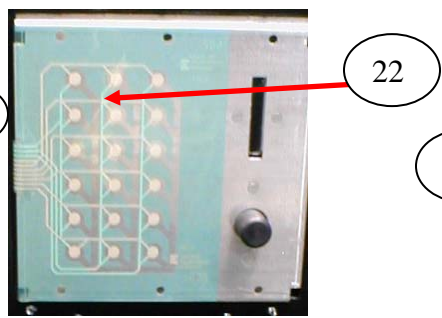
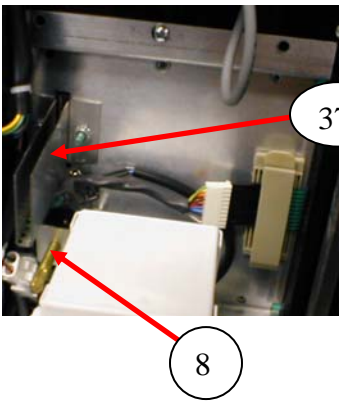
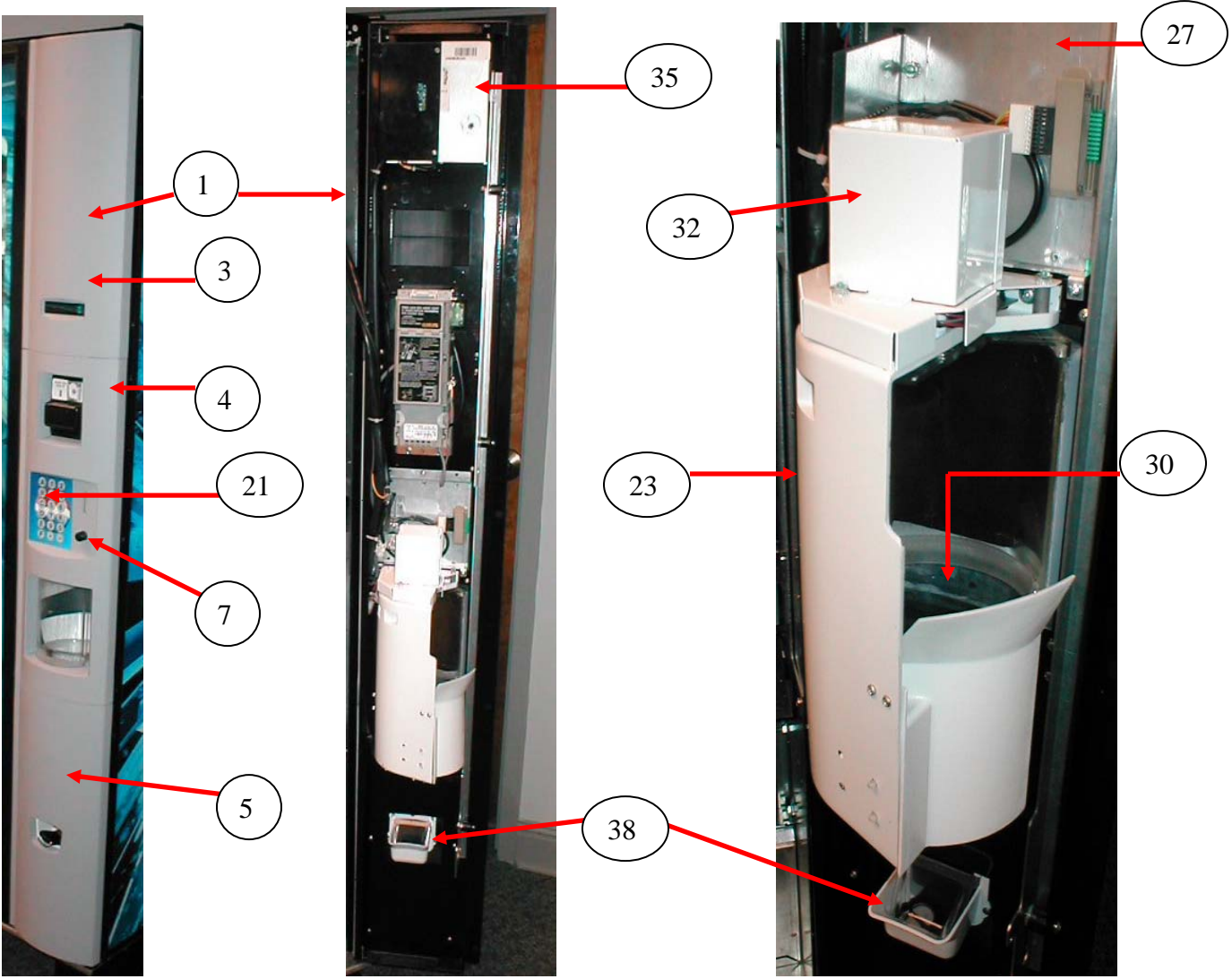

## SERVICE DOOR (OUTSIDE)

ITEM	PART DESCRIPTION	DN5800	DN5800
		Prior to run 8483	Run 8483 & higher
1	Service Door Assembly, Electronic Lock, Gray	<647,050,000.33	647,050,000.33
	Service Door Assembly, Electronic Lock, Card Reader Gray	NA	647,051,90x.x3
	Service Door Assembly, Electronic Lock, Black	<647,051,600.33	647,051,600.33
	Service Door Assembly, Electronic Lock, Card Reader Black	NA	647,052,00x.x3
2	Weld Assembly Service Door	647,050,20x.x3	647,051,70x.x3
3	Assembly Bezel Top, Gray	801,820,45x.x1	801,821,06X.X1
	Assembly Bezel Top, Gray Card Reader	NA	801,821,14x.x1
	Assembly Bezel Top , Black	801,820,92x.x1	801,821,07x.x1
	Assembly Bezel Top , Black Card Reader	NA	801,821,15x.x1
4	Bezel Center, Gray	801,820,15x.x1	801,821,08x.x1
	Bezel Center, Black	801,820,91x.x1	801,821,23x.x1
5	Bezel Bottom Electronic Lock, Gray	801,820,16x.x1	801,821,10x.x1
	Bezel Bottom T Handle, Gray	801,820,94x.x1	801,821,12x.x1
	Bezel Bottom Electronic Lock, Black	801,820,93x.x1	801,821,11x.x1
	Bezel Bottom T Handle, Black	801,820,17x.x1	801,821,13x.x1
6	Coin Return Button Bracket	647,050,07x.x3	Same
7	Coin Return Button Assembly	801,820,53x.x1	Same
8	Coin Return Pusher Rod	800,503,67x.x1	Same
	Coin return Button	801,821,28x.x1	Same
9	Compress Spring	801,701,54x.x1	Same
21	Overlay, Keypad – Pepsi (see page 80 for other Overlay's)	804,101,25x.x1	Same
22	Keypad, Membrane Switch Assembly	804,101,21x.x1	Same
23	Assembly Port	647,050,60x.x3	647,051,10x.x3
24	Assembly LED and Switch, Port	804,924,49x.x1	Same
25	Port Cam	801,821,02x.x1	Same
26	Bracket and Motor Assembly	647,050,30x.x3	Same
27	Motor Mount Product Door Bracket	647,050,05x.x3	Same
28	Cup/Port Motor	804,501,39x.x1	Same
29	Vend Sensor Plate - 801,307,82x.x1?	647,050,14x.x3	Same
30	Port Discharge Pad	803,601,22x.x1	Same
31	Vend Sensor	804,801,06x.x1	804,924,63x.x1
32	Motor Port Cover	801,820,68x.x1	Same
33	Port Handoff Slide	801,820,04x.x1	Same
34	PCA IR Sensor Lock	804,923,97x.x1	Same
35	Assembly Electronic Lock Gray	647,001,50x.x3	Same
	Assembly T Handle Gray	647,002,30x.x3	Same
	Assembly Electronic Lock Black	647,002,20x.x3	Same
	Assembly T Handle Black	647,001,60x.x3	Same
36	Harness, Electronic Lock	804,923,41x.x1	Same
37	Coin Insert Chute	647,050,09x.x3	Same
38	Coin Return Cup Assembly	801,820,38x.x1	801,821,29x.x1
39	Coin Cup Door	801,819,35x.x1	801,821,33x.x1
40	Coin Cup	801,820,39x.x1	801,821,30x.x1

Part numbers & descriptions are subject to change with out notice.

NA = Not applicable

# SERVICE DOOR (INSIDE)

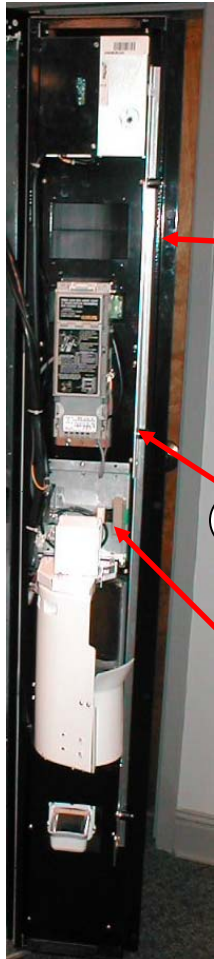
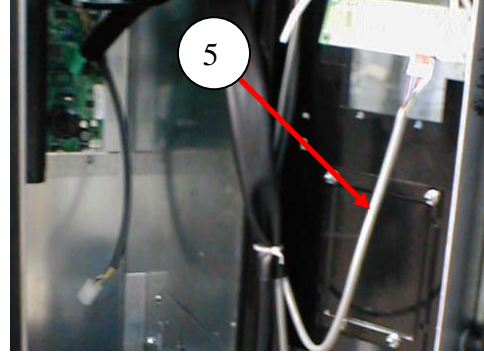
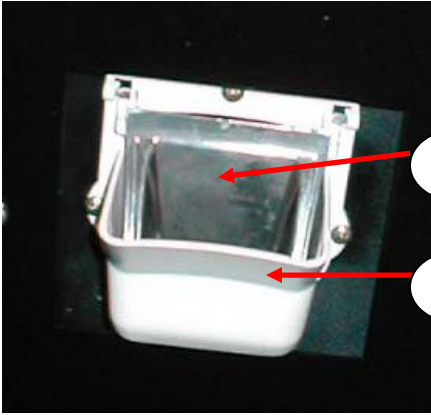
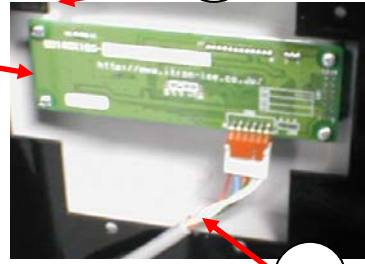
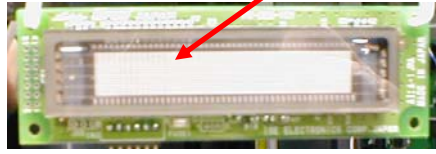

## SERVICE DOOR (INSIDE)

ITEM	PART DESCRIPTION	DN5800	
		Prior to run 8483	Run 8483 & higher
1	Display Lens	801,814,21x.x1	Same
2	Display Spacer – standoff	TBD	Same
3	Assembly Display (Noritake)	804,923,86x.x1	Same
4	Cover, Display	TBD	Same
5	Door Bundle Harness	804,924,25x.x1	Same
6	Coin Return Cup Assembly	801,820,38x.x1	801,821,29x.x1
7	Change Cup Door, prior to run 8483	801,819,35x.x1	801,821,33x.x1
8	Validator Filler Plate	647,050,18x.x3	Same
9	Gasket, Validator Filler Plate	TBD	Same
10	Insert Assembly Service Door Spacer, Lockbar	801,817,47x.x1	Same
11	Assembly, Bracket Coin Mech Panel	647,050,40x.x3	Same
12	Latch – 2 Point Lock	801,305,58x.x1	Same
13	Lock Bar	647,050,02x.x3	Same
14	Washer, Flat .191 ID .50 OD (metal)	900,701,10x.x1	Same
15	Washer, Flat .260 ID x .687 OD (nylon)	900,701,22x.x1	Same
16	Screw, Shoulder 10-32x1/4	900,202,03x.x1	Same
17	Protective Strip, Plastic (2 piece)	801,810,07x.x1	Same
18	Enclosure	801,819,99x.x1	Same
19	DEX Harness Kit	627,020,30x.x4	Same
20	DEX Harness	804,913,97x.x1	Same
21	DEX Harness Bracket	627,010,02x.x3	Same
22	Hex Nut for DEX Harness	800,801,29x.x1	Same
23	Service Door Security Angle	647,050,04x.x3	Same
24	Spacer Lock Bar	801,817,47x.x1	Same
25	Door Display Security Plate	647,050,17x.x3	Same
26	Coin Insert Assembly	647,050,50x.x3	Same
27	Keypad Cable Clamp Kit	D114	Same
28	Keypad Cable Clamp	D588	Same
29	Coin Insert Assembly	647,050,50x.x3	Same
30	T Handle Assembly, Black	<647,001,600.23	647,001,600.23
	T Handle Assembly, Gray	<647,002,300.23	647,002,300.23
31	T Handle Assembly	801,521,88x.x1	Same
32	Hex Washer #29-34, T Handle	901,503,08x.x1	Same
33	Electronic Lock Assembly, Black	647,002,20x.x3	Same
	Electronic Lock Assembly, Gray	647,001,50x.x3	Same
34	E Lock Assembly	805,202,61x.x1	Same
35	E Lock Harness	804,923,41x.x1	Same

Part numbers & descriptions are subject to change  
with out notice.  
NA = Not applicable  
TBD = To be determined

# GATE TRAY DETAIL

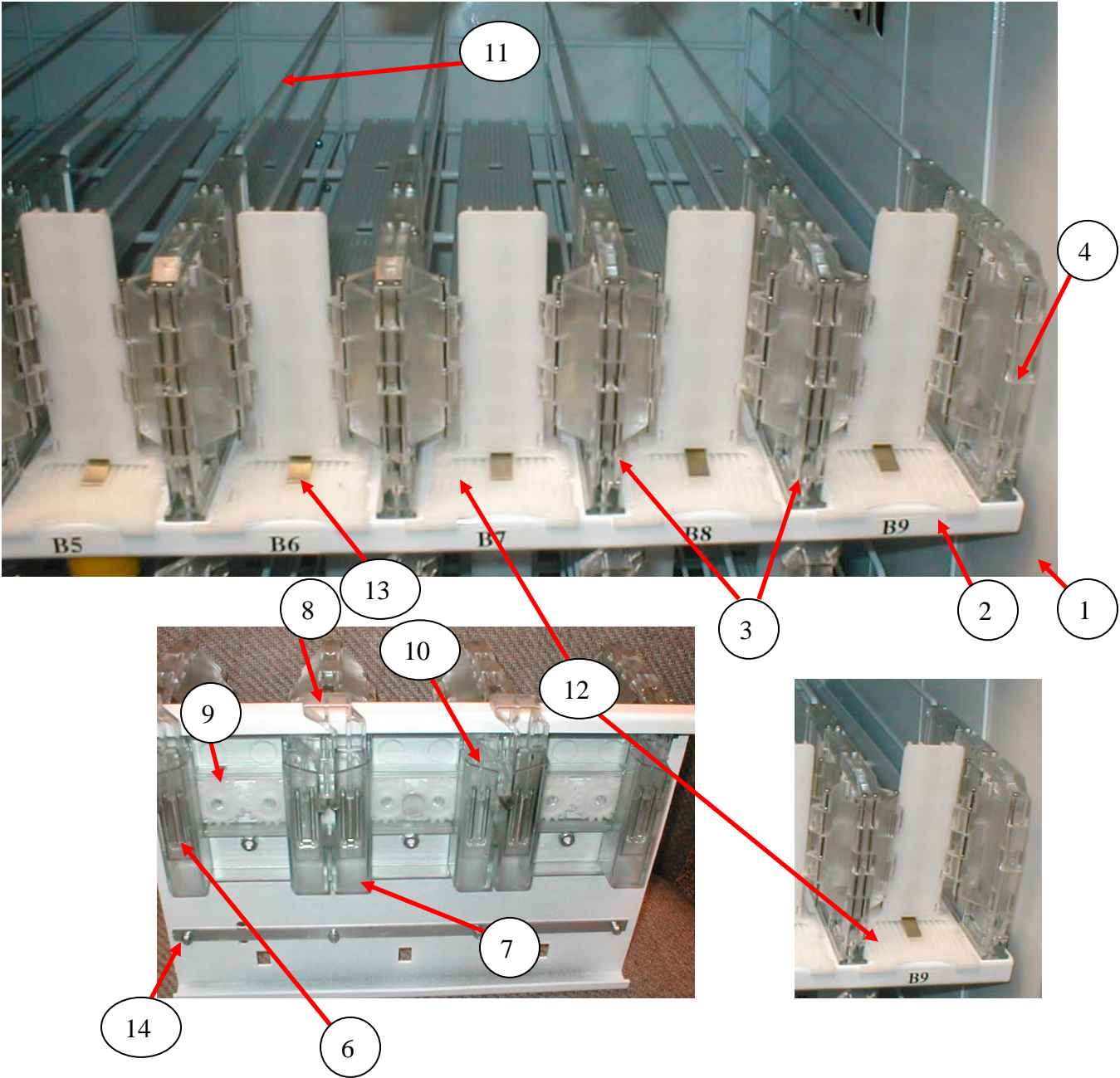



# AC DISTRIBUTION BOX

Export AC Box Shown

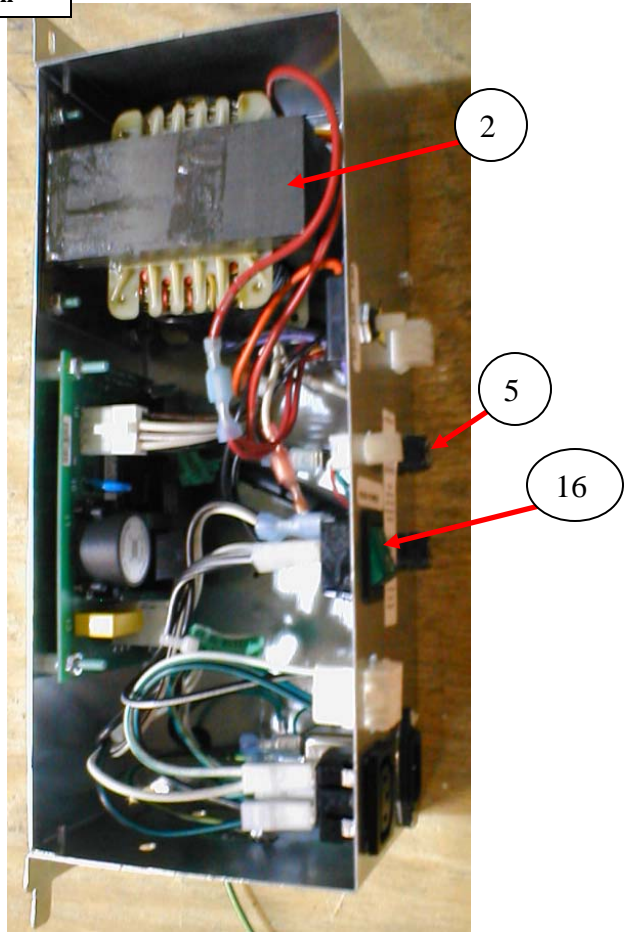
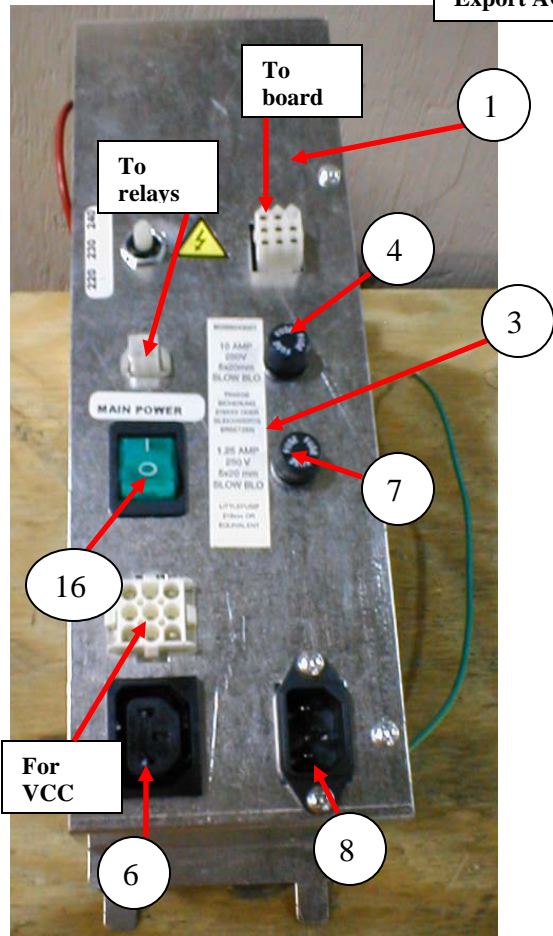

Domestic AC Box Shown

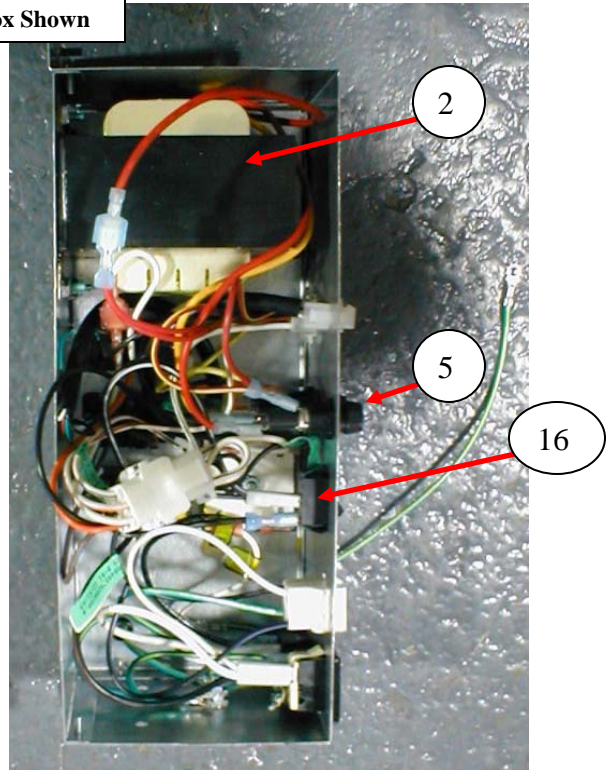
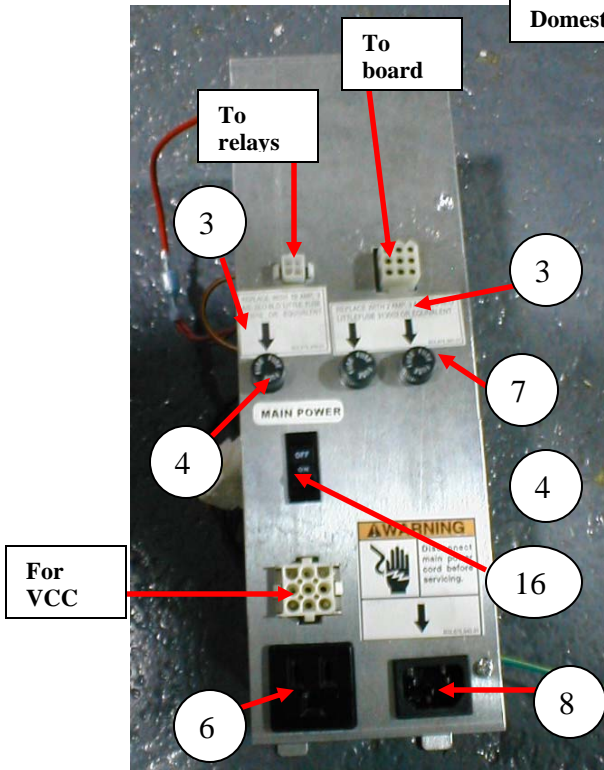

## AC DISTRIBUTION BOX

ITEM	PART DESCRIPTION	DN5800	
		Domestic	Export
1	Assembly AC Distribution T8 Electronic Bev Max 2	647,070,00x.x3	647,075,10x.x3
2	Transformer, 120V / 24V, 60 Hz, 8A Domestic	804,915,54x.x1	NA
	Transformer, Export	NA	804,914,18x.x1
3	Fuse Label, 10 Amp	803,876,95x.x1	NA
	Fuse Label, 2 Amp	803,876,96x.x1	NA
	Fuse Label Export	NA	803,880,4x.x1
4	Fuse, 10 Amp, 32V SloBlo	W659	Same
5	Fuse Holder, Panel Mounted, Quick Disconnect 5X20mm	804,914,88x.x1	Same
6	Outlet, 15 Amp, Grounded	W662	TBD
7	Fuse, 1.25 Amp, 250V, SloBlo 5 X 20mm	804,919,56x.x1	Same
8	Power Inlet Plug	804,913,62x.x1	Same
9	Harness, AC Power & Choke Input	804,922,92x.x1	804,924,42x.x1
10	Harness, Power Distribution	804,922,93x.x1	TBD
11	Harness, Choke Output	804,920,49x.x1	NA
12	Harness, MDB Interior Power T8/Electronic GFV	804,923,38x.x1	NA
13	Harness, Main Power	622,060,60x.x3	NA
14	Choke	804,920,42x.x1	NA
15	Relay – Fan, Compressor, and Light	804,200,26x.x1	Same
16	Rocker Switch, Hi In rush	804,915,15x.x1	804,101,12x.x1
17	Harness, Relay	804,922,94x.x1	804,924,44x.x1
18	Label Power Disconnect	803,876,94x.x1	803,880,43x.x1
19	Circuit Board Assembly	TBD	804,922,58x.x1
20	3 Position Switch	NA	804,916,93x.x1
21	Filter EMI IEC Inlet 10 Amp	NA	804,801,14x.x1
22	Harness, AC Out Power Box	NA	804,924,43x.x1

Part numbers & descriptions are subject to change with out notice.  
 NA = Not applicable  
 TBD = To be determined



## LIGHTING

ITEM	PART DESCRIPTION	DN5800	DN5800
		Domestic	Export
1	Ballast Assembly, T 8 Electronic 110 Volt/60 Hertz (Advance)	804,400,61x.x1	NA
2	Ballast Assembly, 220 Volt/50 Hertz	NA	804,401,11x.x1
3	Lens, Fluorescent Lamp Assembly (28.35")	801,603,05x.x1	Same
	Lens, Fluorescent Lamp Assembly (23.938")	801,603,06x.x1	Same
4	Fluorescent Lamp T8, 2' (OS #21718)	804,700,77x.x1	NA
	Fluorescent Lamp T8, 2' (OS #23041)	NA	804,701,03x.x1
5	Light Harness, 120 Volt – 3 Lamp T8	804,923,39x.x1	804,924,52x.x1
	Light Harness, 120 Volt – 1 Lamp T8 (Upper Light Assy.)	804,923,63x.x1	804,824,51x.x1
6A	Lamp Holder, T8 Bi Pin - Leviton 23652 (Vertical)	804,920,62x.x1	Same
	Lamp Holder, T8 Bi Pin - Leviton 23653 (Horizontal)	TBD	Same
7	Light Assembly T8 Domestic	647,060,60x.x3	647,060,28x.x3
8	Assembly Lamp Channel 2"	647,060,20x.x3	647,060,29x.x3
9	Lamp Holder Bracket	647,060,05x.x3	Same
10	Upper Light Assembly	647,000,00x.x3	647,002,40x.x3
11	End Cap Lamp	801,904,62x.x1	Same
12	Lamp Cover (22.6")	801,819,89x.x1	Same
13	Choke	804,920,41x.x1	TBD
14	Choke Cover	801,821,68x.x1	TBD
15	Choke Harness	804,924,46x.x1	TBD

Part numbers & descriptions are subject to change with out notice.

NA = Not applicable

TBD = To be determined

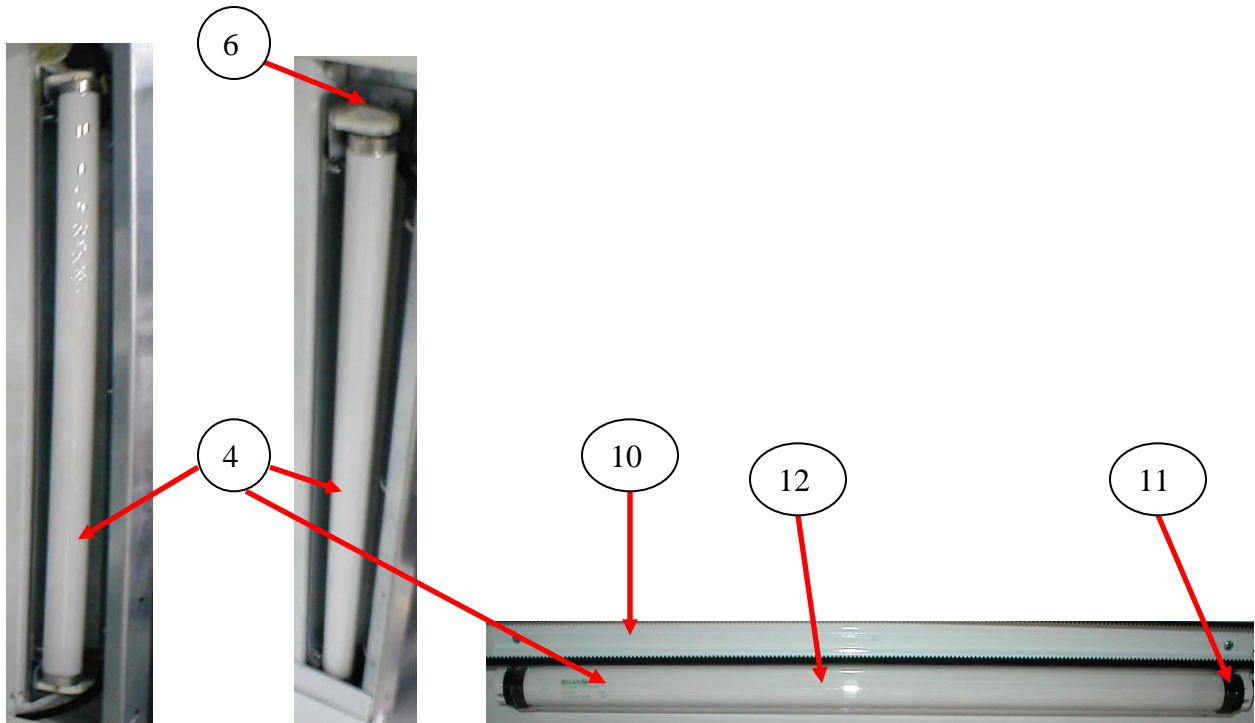

**REFRIGERATION UNIT  
(Bev Max 2 FIN & TUBE CONDENSER)**

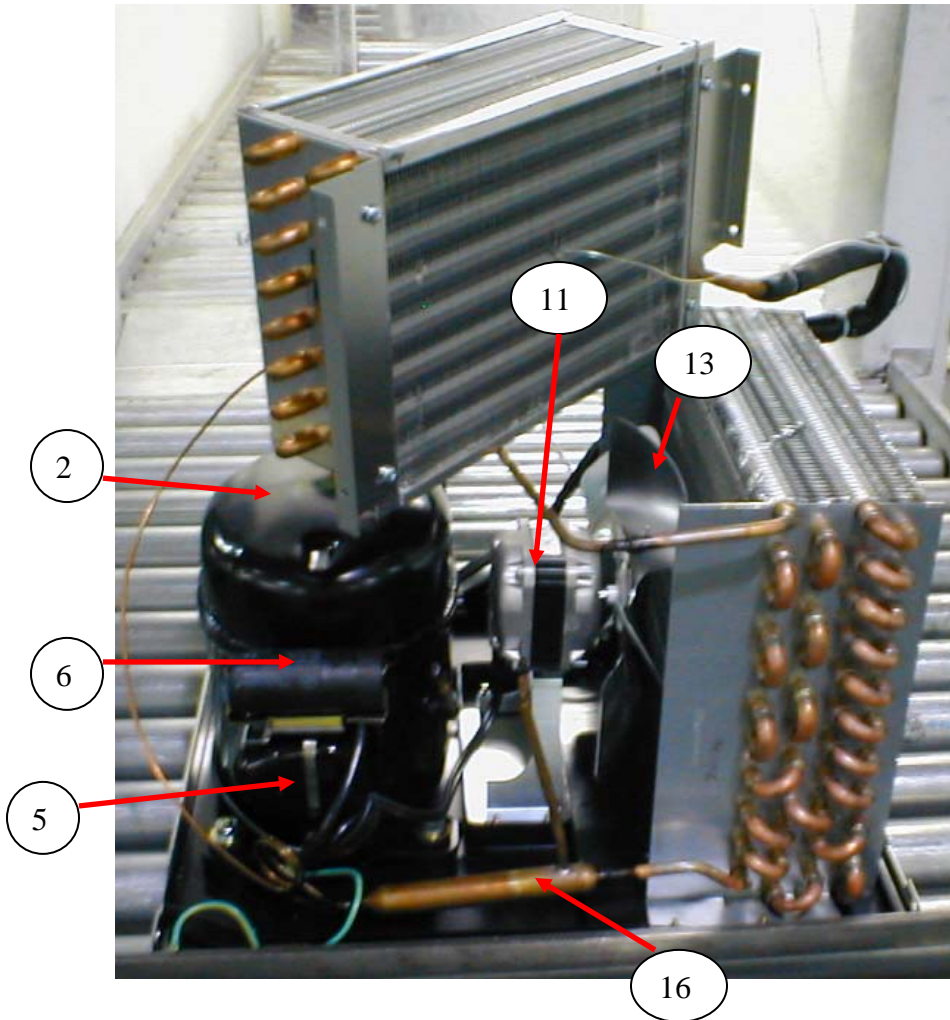
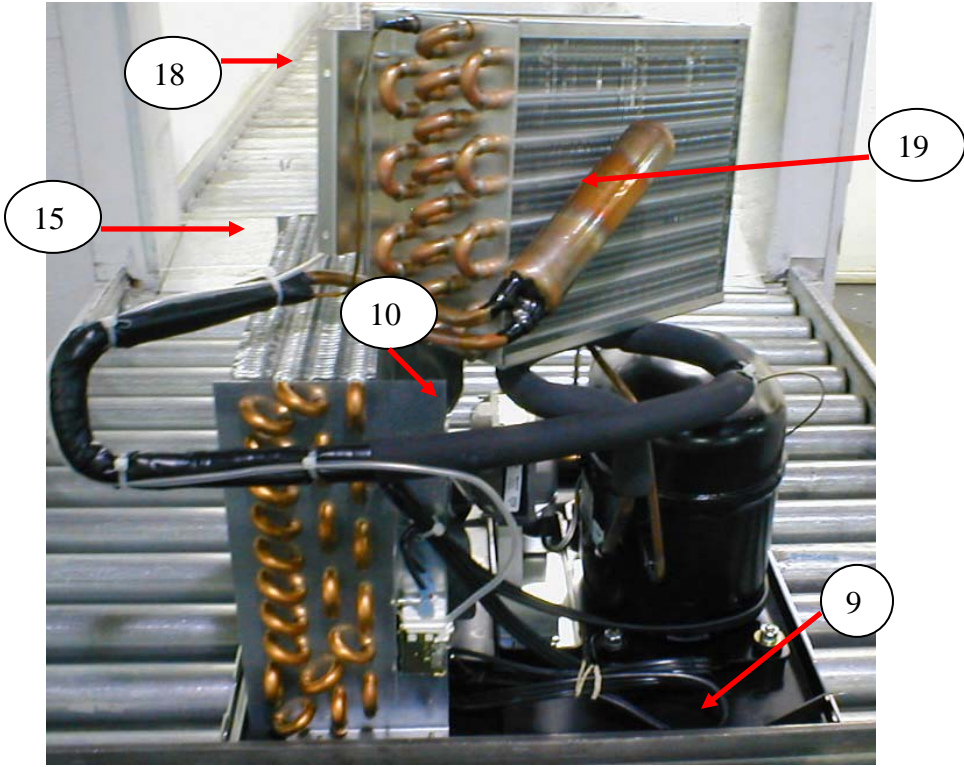

**REFRIGERATION UNIT**  
**(Bev Max 2 - FIN & TUBE CONDENSER)**

ITEM	PART DESCRIPTION	DN5800	DN5800
		Domestic	Export
1A	Refrigeration Unit EM2001 C-A Kit, 115V/60Hz Domestic Kit	627,012,10x.x3	NA
	Refrigeration Unit EM2021 C-A Kit, 220V/50Hz Export Kit	NA	635,040,20x.x4
1B	Refrigeration Unit EM2001 C-A, 115V/60Hz Domestic	802,502,47x.x1	NA
	Refrigeration Unit EM2021 C-A, 220V/50Hz Export	NA	635,040,10x.x4
2	Compressor Assy. 115V/60Hz Domestic	TBD	NA
	Compressor Assy. 220V/50Hz Export	NA	626,041,30x.x3
2A	Compressor, Domestic	TBD	NA
2B	Compressor, Export	TBD	802,502,25x.x1
3A	Overload, 115V Domestic	TBD	NA
3B	Overload, 220V Export	TBD	802,502,26x.x1
4A	Relay, 110V -Domestic	TBD	NA
4B	Relay, 220V -Export	TBD	802,502,27x.x1
5	Cover, Overload/Relay Tecumseh	TBD	802,502,01x.x1
6A	Start Capacitor, 110V – Domestic	TBD	NA
6B	Start Capacitor, 250V/50Hz Export	TBD	802,502,28x.x1
7	Start Capacitor, End Cap Bottom Hole	TBD	802,501,18x.x1
8	Bracket, Capacitor Assembly	TBD	802,501,87x.x1
9A	Drain Pan, Condensate - Domestic	TBD	
9B	Drain Pan, Condensate - Export	TBD	
10A	Assembly Condenser Fan, 10” Domestic	TBD	NA
10B	Assembly Condenser Fan , 220V Export	TBD	626,041,40x.x3
11A	Condenser Fan Motor, Domestic	TBD	NA
11B	Condenser Fan Motor, Export	TBD	804,501,18x.x1
12	Silencer	TBD	902,100,29x.x1
13	Fan Blade, Condenser	TBD	801,305,67x.x1
14	Speed Nut	TBD	900,800,85x.x1
15	Condenser	TBD	802,600,64x.x1
16	Dryer	TBD	802,401,30x.x1
17	Grommet Compressor	TBD	902,000,57x.x1
18	Evaporator	TBD	802,600,63x.x1
19	Accumulator	TBD	802,401,35x.x1
	Part numbers & descriptions are subject to change with out notice. NA = Not applicable TBD = To be determined		

**REFRIGERATION UNIT**  
**(Bev Max 2 - FIN & TUBE CONDENSER)**

20	Temperature Control Clip	800,902,63x.x1	800,902,63x.x
21	Refrigeration Holding Bracket	647,040,02x.x3	647,040,02x.x3
22	Temperature Sensor Control Board	804,916,29x.x1	804,916,29x.x1
*23	Assembly Evaporator Fan 115V Energy Star (5 blade)	647,052,10x.x3	NA
	Assembly Evaporator Fan 115V Energy Star (7 blade)	627,052,40x.x3	NA
	Assembly Evaporator Fan 220V/50Hz	NA	622,043,00x.x3
**24	Evaporator Fan, EBM (5 blade) 115V	804,501,48x.x1	NA
	Evaporator Fan, 58mm ECM (7 blade) 115V	804,501,28x.x1	NA
	Evaporator Fan, 220-230V/50Hz	NA	804,501,11x.x1
25	Choke	804,920,41x.x1	NA

Part numbers & descriptions are subject to change with out notice.  
NA = Not applicable  
TBD = To be determined  
\*\*Important: An EBM fan will not fit in the ECM fan housing assy.  
\*The Evaporator Fan Assys. Are interchangeable in the vender.

## ELECTRONICS

ITEM	PART DESCRIPTION	DN5800	DN5800
		Domestic	Export
1	Bev-Max 2 Control Board Assembly, New	647,061,40x.x3	TBD
	Bev-Max 2 Control Board Assembly, Reconditioned	647,061,50x.x3	TBD
2	Standoffs	801,903,80x.x1	Same
3	EPROM, Firmware Bev-Max 2	804,924,08x.x1	TBD
4	Display Assembly	804,923,86x.x1	Same
5	Transformer	804,915,54x.x1	804,914,18x.x1
6	Fuse, 3 Amp 5 X 20mm Sloblo	804,801,16x.x1	Same
7	Battery, 3 Volt Lithium	804,920,45x.x1	Same
8	Temp Sensor Cable	804,917,24x.x1	Same
9	Temp Sensor Control Board	804,916,29x.x1	Same
10A	Choke, AC Distribution Box only	804,920,42x.x1	NA
10B	Choke, Evaporator Fan Assembly & Lighting	804,920,41x.x1	Same
11	Board Y Motor	804,923,54x.x1	Same
12	Health Timer Control Assembly	622,010,50x.x4	Same
13	Motor XY System	804,501,41x.x1	Same
14	LED & Switch Port Assembly	804,924,49x.x1	Same
15	Control Board Cover	647,000,38x.x3	Same
16	Temp Control Clip	800,902,63x.x1	Same

Part numbers & descriptions are subject to change with out notice.  
 NA = Not applicable  
 TBD = To be determined

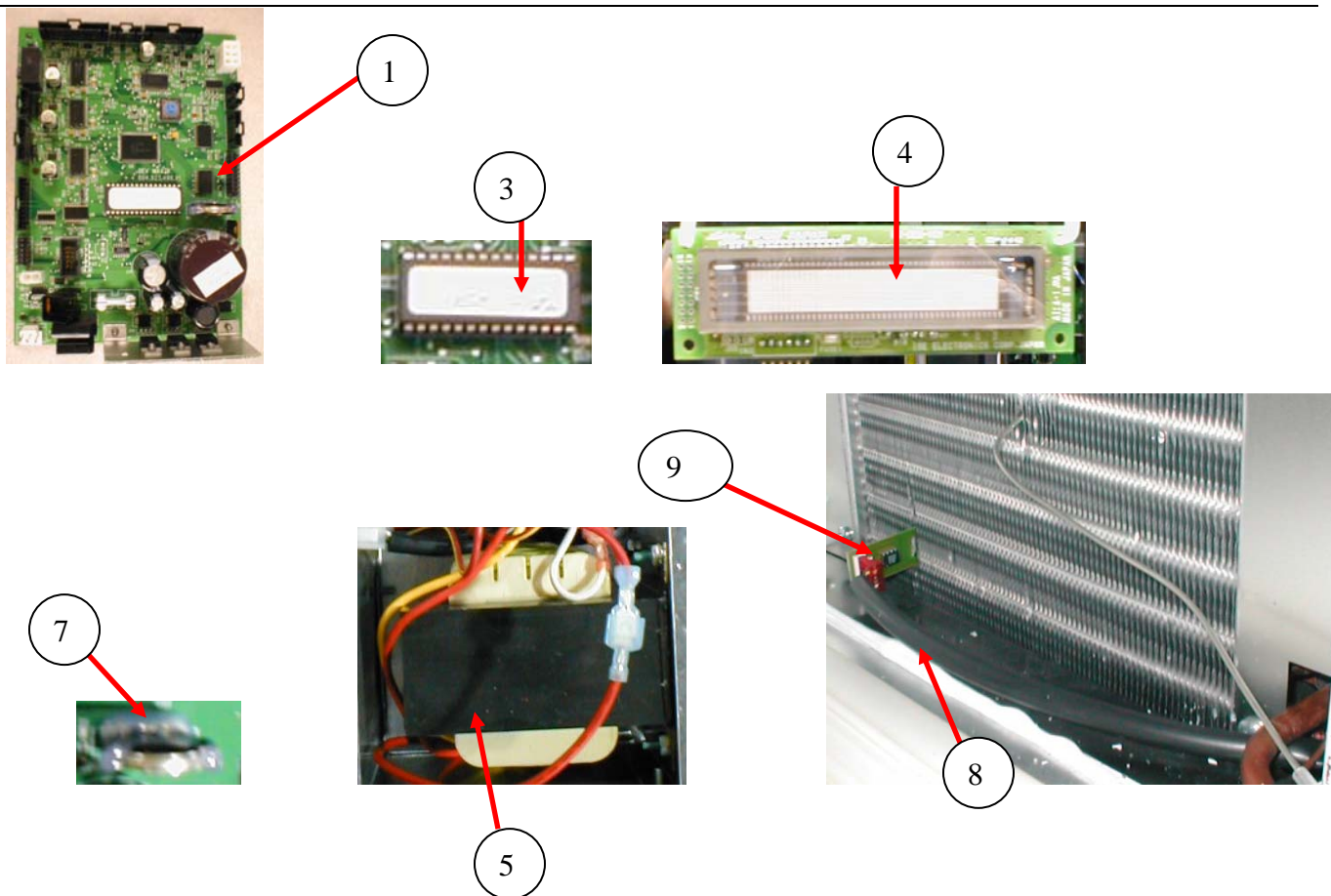

# HARNESSES

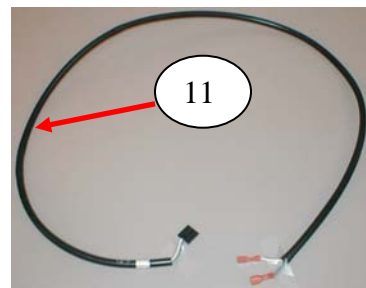
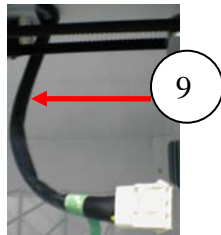
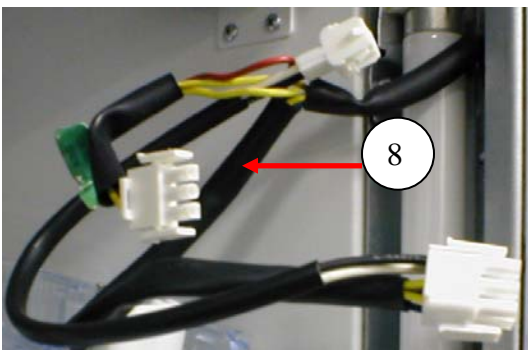
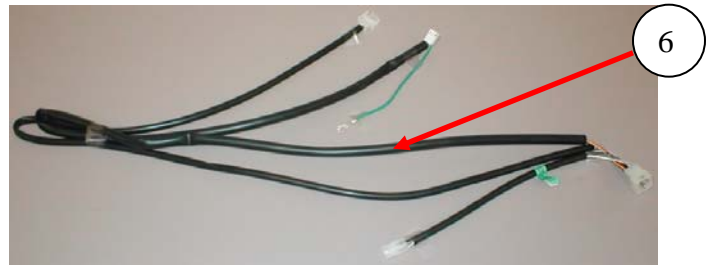
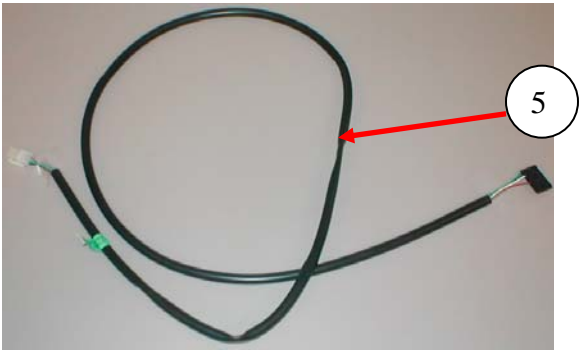
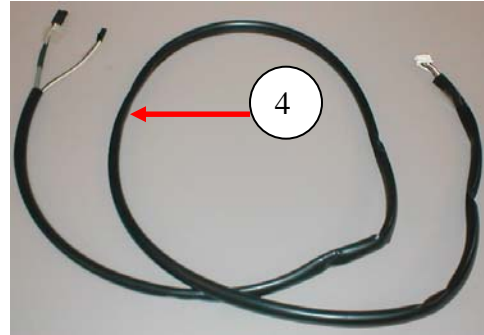
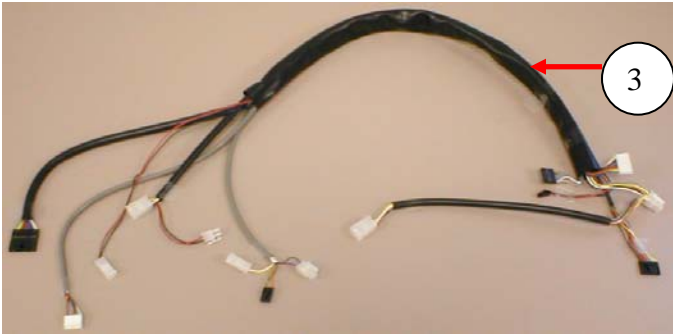
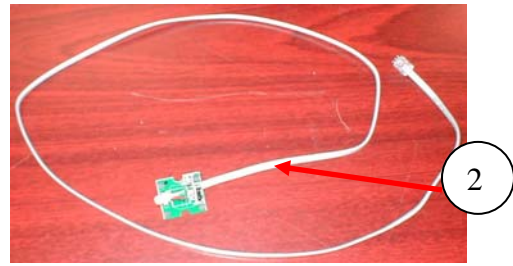
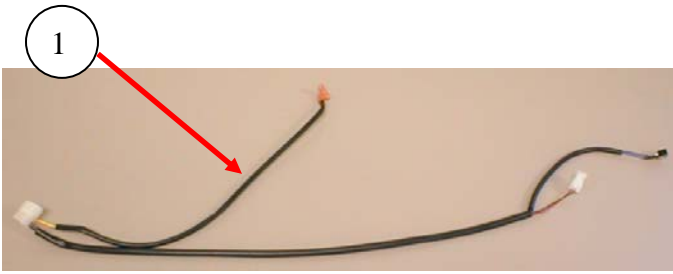

## HARNESSES

ITEM	PART DESCRIPTION	FROM/TO	DN5800 Domestic	DN5800 Export
1	Harness, Electronic Lock	12 pin plug to E Lock board	804,923,41x.x1	Same
		2 connectors to door switch		
		1 jack in top of port		
		2 pin cap to top port lock board		
2	Harness, Key Sensor	Phone jack to top port lock board		
3	Harness, Door Bundle	10 pin cap white J11 to 10 pin flat black Keypad	804,924,25x.x1	Same
		7 pin cap black P6 to 6 pin flat white Display		
		6 pin plug white J16 to mech		
		8 pin cap black P11 to 4 pin cap black Cup Motor & 4 pin plug white Cup bottom		
		2 pin cap black P13 to 2 pin plug white Port Light		
		6 pin white cap MDB not used		
		2 pin white cap to 2 pin white plug ???		
4	Harness, X Motor	5 pin flat black P5 & 2 pin flat black P9 to 6 pin flat white Motor	804,924,24x.x1	Same
5	Harness, Relays	10 pin flat black P7 to 4 pin white plug AC Distribution Box	804,923,66x.x1	Same
6	Harness, AC Distribution Interior Power	3 pin white plug P1 to 9 pin white cap AC Distribution Box, 2 pin white plug evaporator fan, 2 pin plug to lights, & ground wire	804,923,38x.x1	Same
7	Harness, Evaporator	2 pin white plug to evaporator fan	804,922,37x.x1	Same
8	Harness, Lighting 3 Lamp	9 pin white plug to ballast, 2 pin white cap to 2 pin white plug from AC Distribution Box, 3 pin white plug to horizontal light	804,923,39x.x1	804,924,52x.x1
9	Harness, Top Light 1 Lamp	3 pin white cap from horizontal light to 3 pin white plug from lighting harness	804,923,63x.x1	804,924,51x.x1
10	Harness, Y Motor	5 pin flat black P8 to 2 pin flat black Y Motor & Cup Motor, 5 pin flat black P4 to 6 pin white plug Y Motor Encoder, 9 pin flat black P3 to 10 pin flat black to Y Motor & Cup signals, 2 pin white cap to 2 pin white plug at Y Motor	804,923,73x.x1	Same
11	Harness, Door Switch	6 pin flat black P10 to door switch	804,923,85x.x1	Same
12	Harness, Temp Sensor	6 pin plug J12 to Temp Sensor	804,917,24x.x1	Same
13	Harness, Cup Bottom	4 pin plug to bottom of Cup	804,923,65x.x1	Same
14	Harness, Main Power		622,060,60x.x3	NA
15	Harness, AC Power In		804,922,92x.x1	804,924,42x.x1
16	Harness, DEX 15"		804,913,97x.x1	Same
17	Harness, Cup LED Jumper		804,924,48x.x1	Same
18	Harness, Cup to E-Chain		804,923,74x.x1	Same
19	Harness, Fan Choke Ext.		804,922,77x.x1	NA
20	Harness, Board to Y Motor		804,924,21x.x1	Same
21	Harness, X/Y Chain		804,924,26x.x1	Same
22	Harness, Lighting Choke		804,924,47x.x1	NA
23	Harness, Light Choke Ext.		804,924,46x.x1	NA
24	Harness, Interlock		804,924,29x.x1	Same
25	Harness, Power Dist.		804,922,93x.x1	NA
26	Harness, Choke Output		804,920,49x.x1	NA
27	Harness, Relay		804,922,94x.x1	804,924,44x.x1
		Part numbers & descriptions are subject to change with out notice. NA = Not applicable TBD = To be determined		

## LABELS / DECALS / MISC.

ITEM	PART DESCRIPTION	DN5800
1	Vender Lag Bracket Kit	627,020,60x.x4
2	DEX Kit – Includes bracket, 15” harness, & hardware	627,020,30x.x4
3	Thermometer	801,401,55x.x1
4	Label Set, Price and Product	W485-2 thru 12
5	Label Set, Product Only (i.e. A1, A2, etc.)	803,857,26x.x1
6	Label, Selection - Bev-Max 2	803,857,26x.x1
7	Label, Warning “DO NOT TILT”	803,868,29x.x1
8	Label, Programming	TBD
9	Label, Coin Mech	803,853,25x.x1
10	Label, Coin Return Service Door Bezel	803,857,25x.x1
11	Label, AC Distribution Box Power Disconnect	803,876,94x.x1
12	Decal, Side Cabinet – Blue Cap	803,872,61x.x1
	Decal, Side Cabinet - Gatorade	803,881,91x.x1
	Decal, Side Cabinet - Aquafina	803,874,34x.x1
13	Decal , Glass Door - Pepsi	803,877,42x.x1
	Decal , Glass Door – Gatorade	803,880,31x.x1
	Decal , Glass Door – Aquafina	803,880,26x.x1
	Decal , Glass Door – 7 Up	803,880,99x.x1
	Decal , Glass Door – Black	803,881,86x.x1
	Decal , Glass Door – Neon Blue	803,877,41x.x1
	Decal , Glass Door – Snapple	803,879,96x.x1
14	Decal, Cup Base – Pepsi	803,877,44x.x1
	Decal, Cup Base – Gatorade	803,880,32x.x1
	Decal, Cup Base – Aquafina	803,880,27x.x1
	Decal, Cup Base – 7 Up	803,881,02x.x1
	Decal, Cup Base – Black	803,881,87x.x1
	Decal, Cup Base – Neon Blue	803,877,43x.x1
	Decal, Cup Base – Snapple	803,879,95x.x1
15	Decal, Sleeve – Pepsi	803,877,46x.x1
	Decal, Sleeve – Gatorade	803,880,37x.x1
	Decal, Sleeve – Aquafina	803,880,36x.x1
	Decal, Sleeve – 7 Up	803,881,01x.x1
	Decal, Sleeve – Black	803,881,88x.x1
	Decal, Sleeve – Neon Blue	803,877,45x.x1
	Decal, Sleeve – Snapple	803,879,97x.x1
16	Product Pusher Flavor Card Sheet Pepsi Domestic 1 was 803,862,39x.x1	803,876,32x.x1
17	Product Pusher Flavor Card Sheet Pepsi Domestic 2 was 803,862,40x.x1	803,876,32x.x1
	Product Pusher Flavor Card Sheet Aquafina Domestic	803,876,97x.x1
18	Product Pusher Flavor Card Sheet Generic Domestic 1 was 803,862,41x.x1	Obsolete
19	Product Pusher Flavor Card Sheet Generic Domestic 2 was 803,862,42x.x1	Obsolete
20	Wiring Diagram, Domestic	803,881,93x.x1
21	Wiring Diagram, Export	803,881,76x.x1
22	Decal, Top Bezel Gatorade	803,880,33x.x1
23	Decal, Top Bezel Aquafina	803,880,28x.x1
24	Pepsi BevMax 2 Manual, Service / Operation / Parts prior to 8487 (includes 8511)	803,904,05x.x1
	Pepsi BevMax 2 Manual, Service / Operation / Parts 8487 & higher (except 8511)	803,904,23x.x1
25	Overlay Keypad - Pepsi	804,101,25x.x1
	Overlay Keypad - Aquafina	803,880,29x.x1
	Overlay Keypad - Gatorade	803,880,34x.x1
	Overlay Keypad – 7 Up	803,881,04x.x1
	Overlay Keypad - Black	803,881,89x.x1
	Overlay Keypad – Neon Blue	803,879,17x.x1
	Overlay Keypad – Snapple	803,879,98x.x1
Part numbers & descriptions are subject to change with out notice. NA = Not applicable TBD = To be determined		





# SCREWS & NUTS

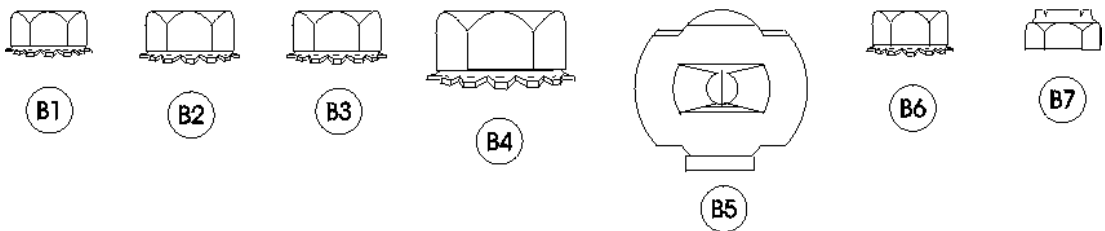
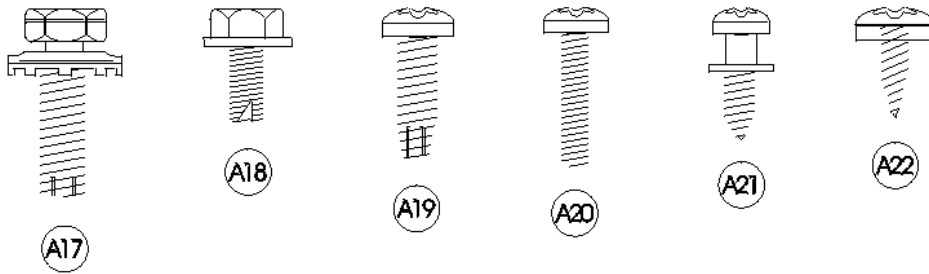
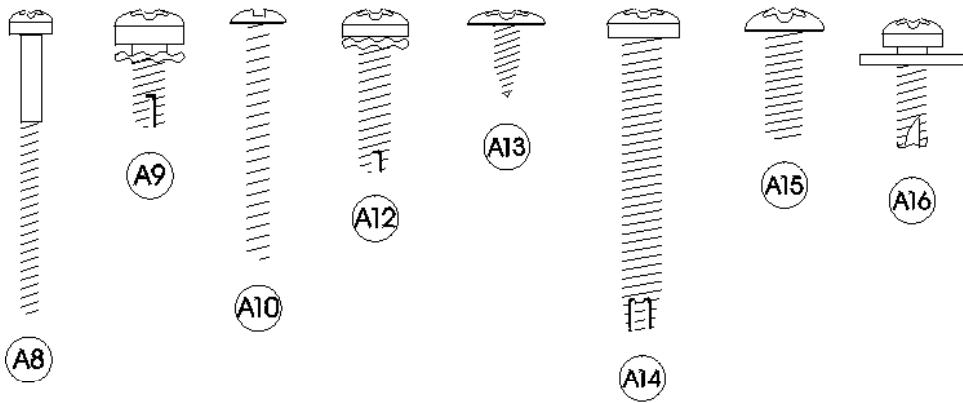
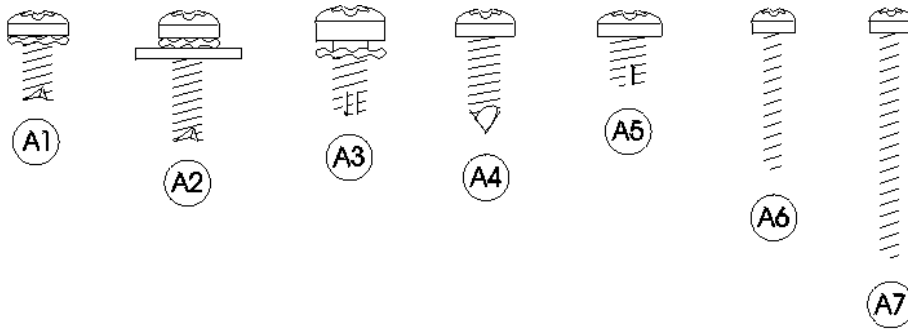

## SCREWS & NUTS

ITEM	PART NUMBER	PART NAME AND DESCRIPTION
A1	900,301,70x.x1	Screw, Phil Pan Swage Form #6 - 32 x 3/8"
A2	900,301,64x.x1	Screw, Phil Pan Swage Form w/washer #8 - 32 x 1/2"
A3	900,301,83x.x1	Screw, Phil Pan Swage Form #10 - 32 x 5/16"
A4	900,301,50x.x1	Screw, Phil Pan w/out washer, #8 - 18 x 1/2"
A5	900,301,97x.x1	Screw, Phil Pan Swage Form #8 - 32 x 1/4"
A6	900,300,47x.x1	Screw, Vend Motor, #4-24 x 3/4" Single Switch (NOT USED)
A7	900,301,82x.x1	Screw, Vend Motor, #4-24 x 1 1/16" Double Switch (NOT USED)
A8	900,301,61x.x1	Screw, Vend Motor, #4-24 x 1 1/2" Triple Switch (NOT USED)
A9	900,301,56x.x1	Screw, Phil Pan Cutting #8 - 32 x 3/8"
A10	900,201,31x.x1	Screw, Machine, #6 - 32 x 1 1/4"
A11	900,301,97x.x1	Screw, Phil Pan Sems #8 - 32 x 1/4"
A12	900,301,85x.x1	Screw, Phil Thread Form #8 - 32 x 5/8"
A13	900,300,16x.x1	Screw, Phil Head Truss #6 x 3/8"
A14	900,301,81x.x1	Screw, Phil Pan Form #10 - 32 x 1 1/4"
A15	900,201,14x.x1	Screw, Machine Truss, #10 - 32 x 1/2"
A16	900,301,65x.x1	Screw, Phil Pan Sems with washer, #8 - 18 x 1/2"
A17	900,302,01x.x1	Screw, Self Tapping, 1/4 - 20 x 5/8"
A18	900,301,69x.x1	Screw, Hex Head Swage Form #8 - 36 x 3/8"
A19	900,901,51x.x1	Screw, Phil Pan Tapping #10 - 32 x 5/8"
A20	900,201,22x.x1	Screw, Machine Phil Pan #8 - 32 x 3/4"
A21	900,301,98x.x1	Screw, Phil Pan Shoulder #8 - 18 x 1/2"
A22	900,301,84x.x1	Screw, Phil Pan #8-18x1/2"
A23	900,500,26x.x1	Shoulder Screw 1/2" Long
A24	900,201,13x.x1	Screw, Hex Head
A25	900,301,73x.x1	Screw, Tap 1/4-20x1" Type F
A26	800,303,15x.x1	Screw, Phil Pan #8-18x3/4"
A27	800,303,18x.x1	Screw, Truss Type 23 #8-32x1/2
A28	900,301,94x.x1	Screw, Phil Flat 23B #10-32x1/2"
A29	900,201,44x.x1	Screw, Machine Brass #6-32x1/4"
A30	900,301,99x.x1	Screw, Plastic 8-hi/low x 1 1/4
A31	900,301,55x.x1	Screw, Phil Pan Swage Form #8-32x1/2"
A32	900,303,08x.x1	Screw, Hex Washer Type 1 #8-32x3/8"
A34	800,303,22x.x1	Screw, Phil Pan #6-20x3/8
A35	900,302,02x.x1	Screw, Self Tapping, #8-18x3/4
A36	900,201,86x.x1	Screw, Phil Pan Head #6-32x1/4"
B1	900,800,65x.x1	Hex Nut, #10 - 32
B2	900,800,67x.x1	Hex Nut, 1/4 - 20
B3	900,800,50x.x1	Hex Nut, #8 - 32
B4	900,800,69x.x1	Hex Nut, Top Door Hinge, 3/8 - 16
B5	900,800,85x.x1	Speed Nut
B6	900,800,49x.x1	Hex Nut, #6 - 32
B7	900,800,51x.x1	Elastic Stop Nut, #8 - 32
B8	900,800,81x.x1	Hex Nut 8-32
B9	900,902,37x.x1	Push Nut, Acorn Type
B10	900,801,02x.x1	Hex Nut 5/16-18
B11	900,800,81x.x1	Hex Nut, Flange with Serrations 8-32

Part numbers & descriptions are subject to change with out notice.

NA = Not applicable

# WASHERS, BOLTS, & MISC. HARDWARE

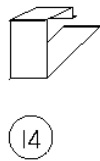
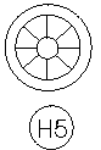
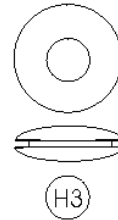
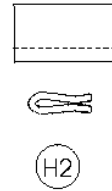
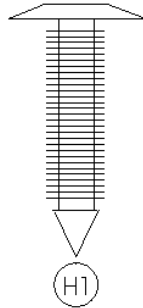
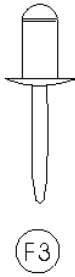
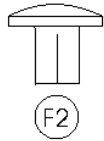
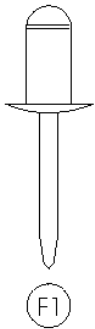
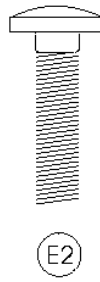
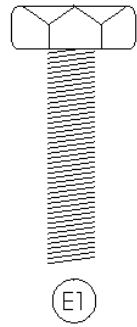
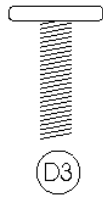
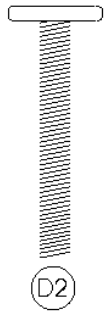
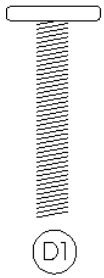
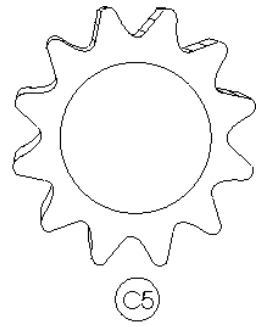
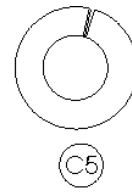
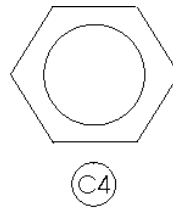
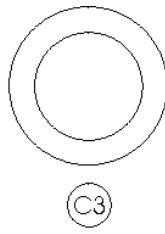
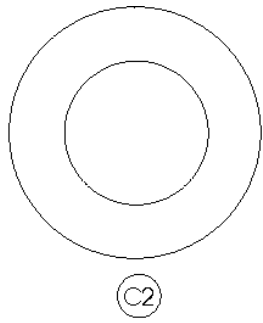
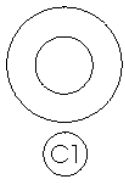

## WASHERS, BOLTS, & MISC. HARDWARE

ITEM	PART NUMBER	PART NAME AND DESCRIPTION
C1	900,700,60x.x1	Washer, Delrin .047 Thick 3/8"IDx5/8"OD
C2	901,303,77x.x1	Washer, Door Hinge
C3	901,503,06x.x1	Washer, Flat #2949 (T-Handle)
C4	901,503,08x.x1	Washer, Hex #29-34 (T-Handle)
C5	900,700,36x.x1	Lockwasher, Split 3/8"
C6	900,700,89x.x1	Lockwasher, Shakeproof 5/8" (1132-00-00-0551)
C7	900,700,02x.x1	Steel Washer, 18 Gauge (1/2"x3/16")
C8	900,700,62x.x1	Washer, Shakeproof (4610-16-01-0551)
C10	900,700,83x.x1	Washer, Flat 18 Gauge (17/64"IDx5/8"OD)
C11	900,700,08x.x1	Washer, Flat 14 Gauge (5/16"-3/8"x7/8")
C12	801,902,48x.x1	Nylon Spacer
	900,701,05x.x1	Washer Flat (.343"ID x .688" OD .6T)
D1	900,400,43x.x1	T-Bolt, #8 - 32 x 1" (obsolete)
D2	900,400,41x.x1	T-Bolt, #8 - 32 x 1 3/8"
D3	900,40x.x5x.x1	T-Bolt, #8 - 32 x 3/4"
D4	900,400,45x.x1	T-Bolt, #8 - 32 x 1/2"
E1	900,400,44x.x1	Refrigeration Bolt, 3/8 - 16 x 1"
E2	900,201,17x.x1	Carriage Bolt, 1/4 - 20 x 1"
E3	900,201,23x.x1	Carriage Bolt, 1/4 - 20 x 1 1/4"
E4	900,201,45x.x1	Carriage Bolt, 1/4 - 20 x 1/2"
E5	900,201,54x.x1	Carriage Bolt, 1/4 - 20 x 3/8"
E6	900,201,56x.x1	Carriage Bolt, 1/4 - 20 x 3/4"
E7	900,303,12x.x1	Carriage Bolt, 1/4-20x5/8" (obsolete)
E8	900,201,85x.x1	Carriage Bolt, 5/16x18x1 1/4" Top Hinge (drop in)
E9	800,303,19x.x1	Carriage Bolt, 1/4-20x5/8"
E10	900,202,04x.x1	Carriage Bolt, 1/4-20x1/2" (red)
F1	901,100,43x.x1	Pop Rivet, Aluminum 1/4"
F2	901,100,44x.x1	Drive Rivet, #38-108-06-13 1/4" dia.
F4	901,100,54x.x1	Pop Rivet, Black 1/8"
F5	901,100,61x.x1	Pop Rivet, Steel (Zinc Plated) 1/8"
F6	901,100,53x.x1	Pop Rivet, Aluminum 1/8"
F7	901,100,60x.x1	Pop Rivet, Steel (Zinc Plated) 3/16"
H1	900,902,13x.x1	Christmas Tree Clip #354280307-00 (NOT USED)
H2	900,901,89x.x1	Tinnerman Clip, Fan Shroud (C5207-014-3B)
H3	900,401,09x.x1	Grommet, Bk. Rubber #97
H4	901,503,07x.x1	E-Ring #31-30
H5	900,900,90x.x1	Retainer, Roller Pin
H6	900,902,18x.x1	Tinnerman Clip
H7	801,807,01x.x1	Hole Plug, Snap in - 1 1/4
H8	901,806,77x.x1	Grommet, Admiral #B53351
H9	902,100,29x.x1	Silencer
I1	804,601,45x.x1	#6 Terminal Ring Crimp 16-14 AWG
I2	801,902,48x.x1	Nylon Spacer
I3	801,809,12x.x1	Velcro Blocks
I4	801,807,49x.x1	Vender Defender Clamp

Part numbers & descriptions are subject to change with out notice.

NA = Not applicable

## WASHERS, BOLTS, & MISC. HARDWARE

ITEM	PART NUMBER	PART NAME AND DESCRIPTION
I5	901,901,89x.x1	Clamp, Cable 1" Heyco 3390
I6	900,901,79x.x1	Clamp, Nylon 5/16" Black Heyco 3355 or Dennison 10159
I7	900,901,80x.x1	Clamp, Nylon 1/2" Heyco 3328
I8	901,901,06x.x1	Hand Tie, x.x"
I9	901,902,01x.x1	Wire Tie, 7 1/2"
I10	901,901,00x.x1	Wire Ties, 4"
I11	901,900,55x.x1	Clamp, Nylon 3/4" Heyco 3382BL
I12	901,902,83x.x1	Cable Tie, x.x"
I13	900,902,14x.x1	Canoe Clip #254-090-301-00-0108

Part numbers & descriptions are subject to change with out notice.

NA = Not applicable